

TALYROND[®] 595 PRO

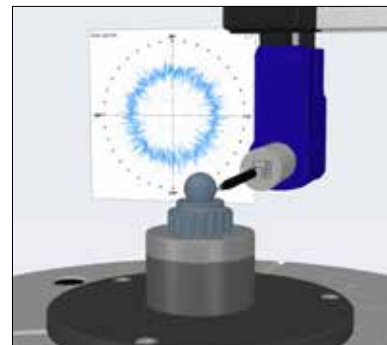
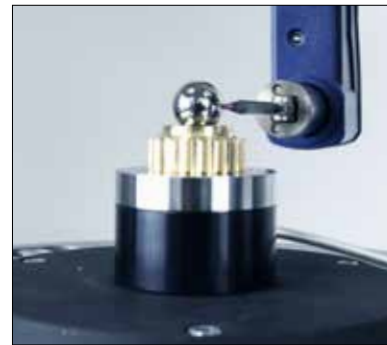

Ultra-high precision roundness measurement

TALYROND[®] 595 PRO HS

Advanced roundness metrology, made simple

High fidelity measurement

The Talyrond[®] 500 PRO is the number one choice for manufactures of precision components including bearings, lens moulds, fuel injectors and much more...

The Talyrond[®] 500 PRO is a world leader in speed, position control and accuracy and has the lowest noise floor of any instrument of its kind. These characteristics combined with the systems unique gauge capability enable measurement of roundness, roughness and contour from a single metrology platform.

With the option of an automated rotary stage or integrated vacuum chuck the system is truly unrivalled in capability and efficiency.

One software platform, multiple disciplines

-  Roundness
-  Roughness
-  Contour
-  Topography

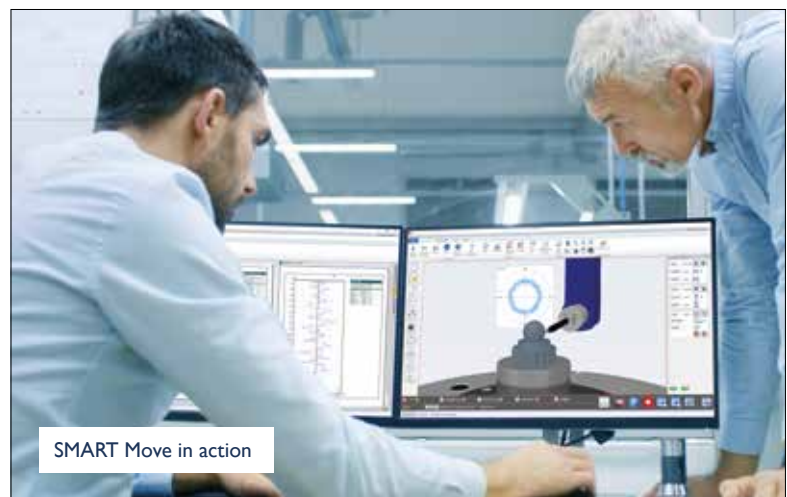

Gauge



Gauge range, up to
4 mm

Resolution, down to
0.3 nm

Roundness



Radial accuracy
± 0.008 µm

Roughness



Noise
< 20 nm Rq all axes

Ra values
< 0.05 µm Rq

Contour



LS Arc measurement
5 µm

Pt
0.5 µm

TALYROND®
powered by



Metrology 4.0®

SMART SOFTWARE

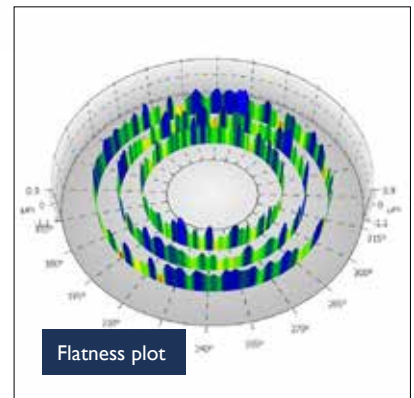
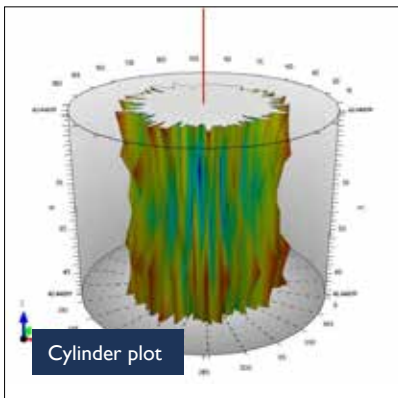

SMART SOFTWARE

Cutting-edge technology

Unique benefits for both design and production

 **Roundness**

Frictionless high precision air bearing spindle provides world leading roundness results

 **Surface Texture**

High resolution gauge and low axis noise enables linear or circumferential surface roughness

 **Contour**

Our patented calibration technique enables measurement of radii, angle, height, length, distance and more

 **Topography**

A fully automated routine enabling 3D topography of cylindrical surfaces

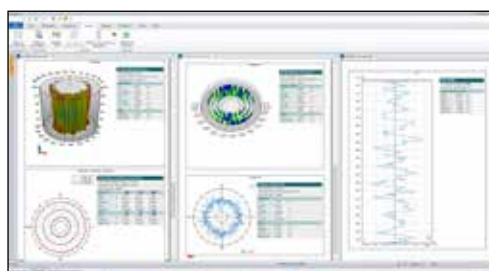
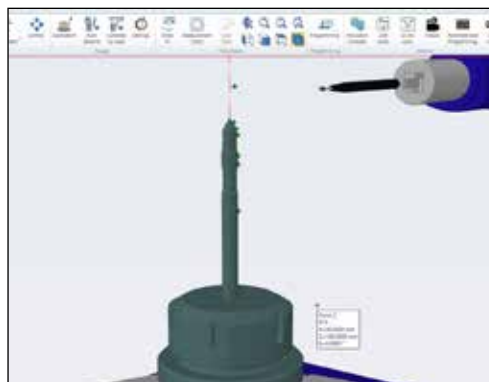
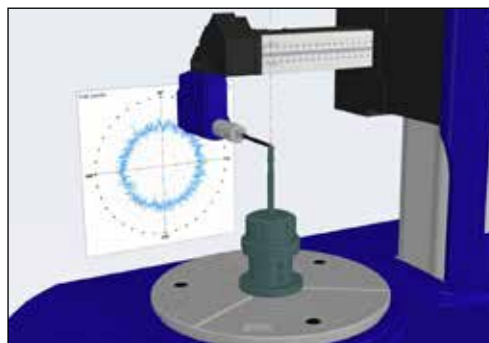

Class-leading

 **Range & Resolution**

 **Noise**

 **Roundness**

 **Flatness**

 **Straightness**

Metrology 4.0 - Smart Software

The advancement in metrology software design that the market has been waiting for...

Taylor Hobson's advanced software enables dimensioning in accordance with part drawings and provides an exact reflection of the Part Co-ordinate System (PCS) delivering the final link in the manufacturing loop.

Metrology 4.0 software is easy to use with an intuitive user-interface, virtual display and real time control. The state-of-the-art point and move axis control function delivers precise positioning and accurate measurement.

" Metrology 4.0 is a quantum leap
in measurement and analysis "

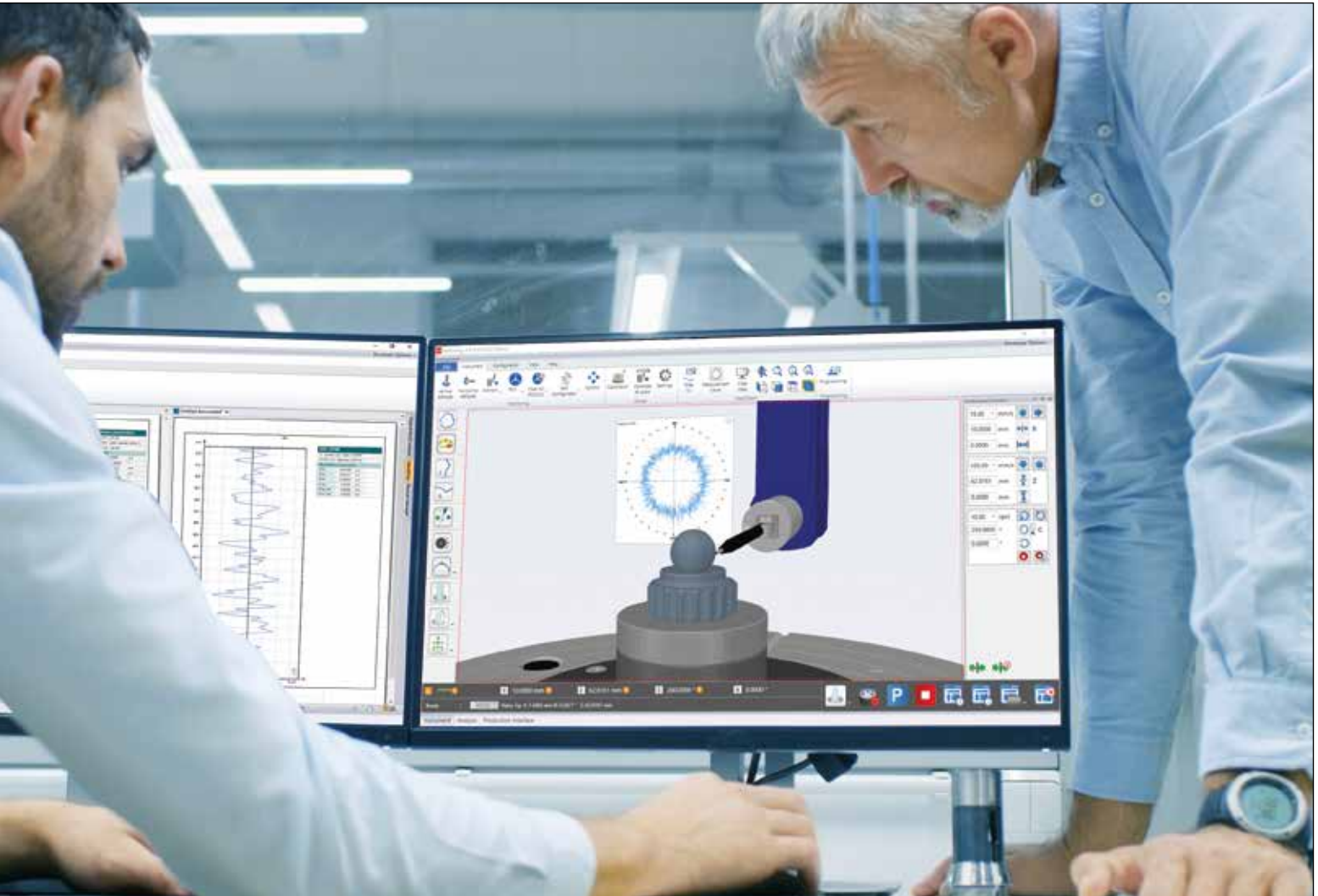

Industry 4.0 in action

All of the critical components for the Talyrond® 595 HS PRO are manufactured in-house at our UK facility, with unique serial numbers for worldwide traceability.

Taylor Hobson has invested in the latest machining techniques to deliver measurement integrity through manufacturing excellence.



"Our strong investment meets the demands of high technology manufacturing"

**Tim Garner, Operations Director.
– Taylor Hobson Ltd.**

Taylor Hobson's latest investment includes the Mazak Integrex i-200S with 10 axis, twin spindle, in cycle probing, tool break detection, unmanned running, temperature control, zero set up times, auto re-loading, high accuracy glass scales and 110 tool capacity.

SMART FACTORY

Industry 4.0 supported by Metrology 4.0

The future of modern manufacturing

Industry 4.0 philosophy is driving what has been called a 'Smart Factory' through the process of automation, data exchange and control in manufacturing environments.

A "Smart Factory" includes a variety of modern technologies such as, Internet of Things, Internet of People, Cloud computing, Smart sensors and Advanced SPC software.

Taylor Hobson's ongoing developments support this approach and are in line with the Industry 4.0 philosophy. Metrology 4.0 software includes an intuitive, easy-to-use and modern Production Interface.

The Q-DAS accredited production interface is designed for shop floor environments and provides direct communication with SPC software, which delivers feedback to your manufacturing process.

This form of monitoring is used widely in automotive and aerospace manufacturing, where traceability and strict standard operating procedure control are mandatory.



Programs reduce operator mistakes



Programmed measurement routines reduce cycle times and increase throughput



Display traceable pass/fail results and automatic summary reports



Tolerancing - Visually identifies the parameter and tolerance band



Historic traceability is made possible via data exchange and part tracking



Control can be managed by barcode scanners or tracking/auditing system



Statistics such as automatic R&R studies



Taylor Hobson metrology directly monitoring production

Modern manufacturing cycle

1. Innovative design
2. State-of-the-art manufacturing
3. Fast and automated part-handling
4. Measurement and analysis powered by Metrology 4.0
5. Feedback of results to data centre for trend analysis
6. Monitor trends in the field or in production
7. Improve quality and efficiency

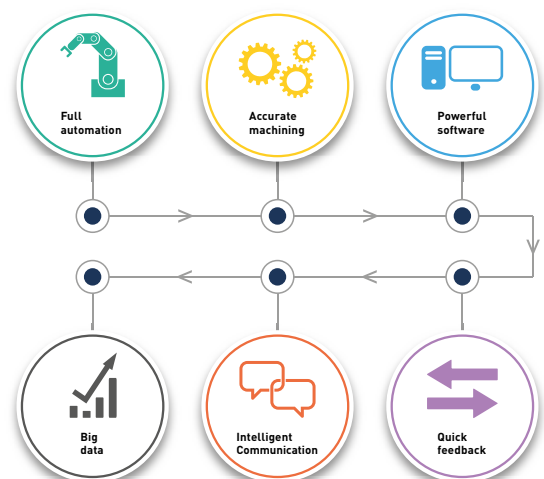

UNIQUE

Cutting-edge technology

✓ Vacuum chuck

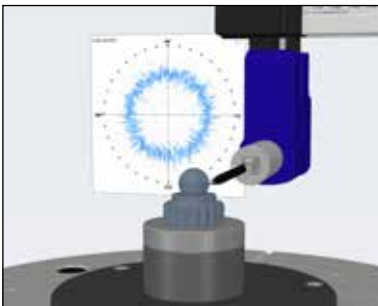

The optional vacuum fixture allows small and delicate components to be held without distortion and also enables greater measurement access by removing the need for direct clamping.

The very low stylus force and vacuum pressure enable components such as miniature ball bearings to be measured for roundness, velocity and harmonic content.

✓ Gauge range and resolution



The world-leading gauge delivers 4 mm of range, twice the range of most roundness instruments. This enables the unique capability of roundness, contour, and roughness measurement from a single gauge.

This universal gauge has a resolution down to 0.3 nm, when coupled with the system's low noise platform, the Talyrond® 595H PRO becomes a fully automated surface texture instrument.

✓ High precision velocity mode

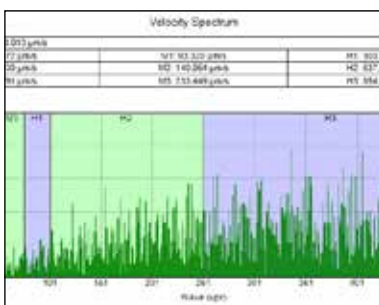

Velocity analysis is a tried and tested facility for assessing low noise, high precision bearings and other precision rotational surfaces.

A critical element when looking at velocity, harmonics and none round components such as camshafts is the high resolution encoder. This ensures exact replication of harmonic frequencies and form on bearings, camshafts and other rotational components.

Vacuum chuck - small and delicate components can be held without distortion

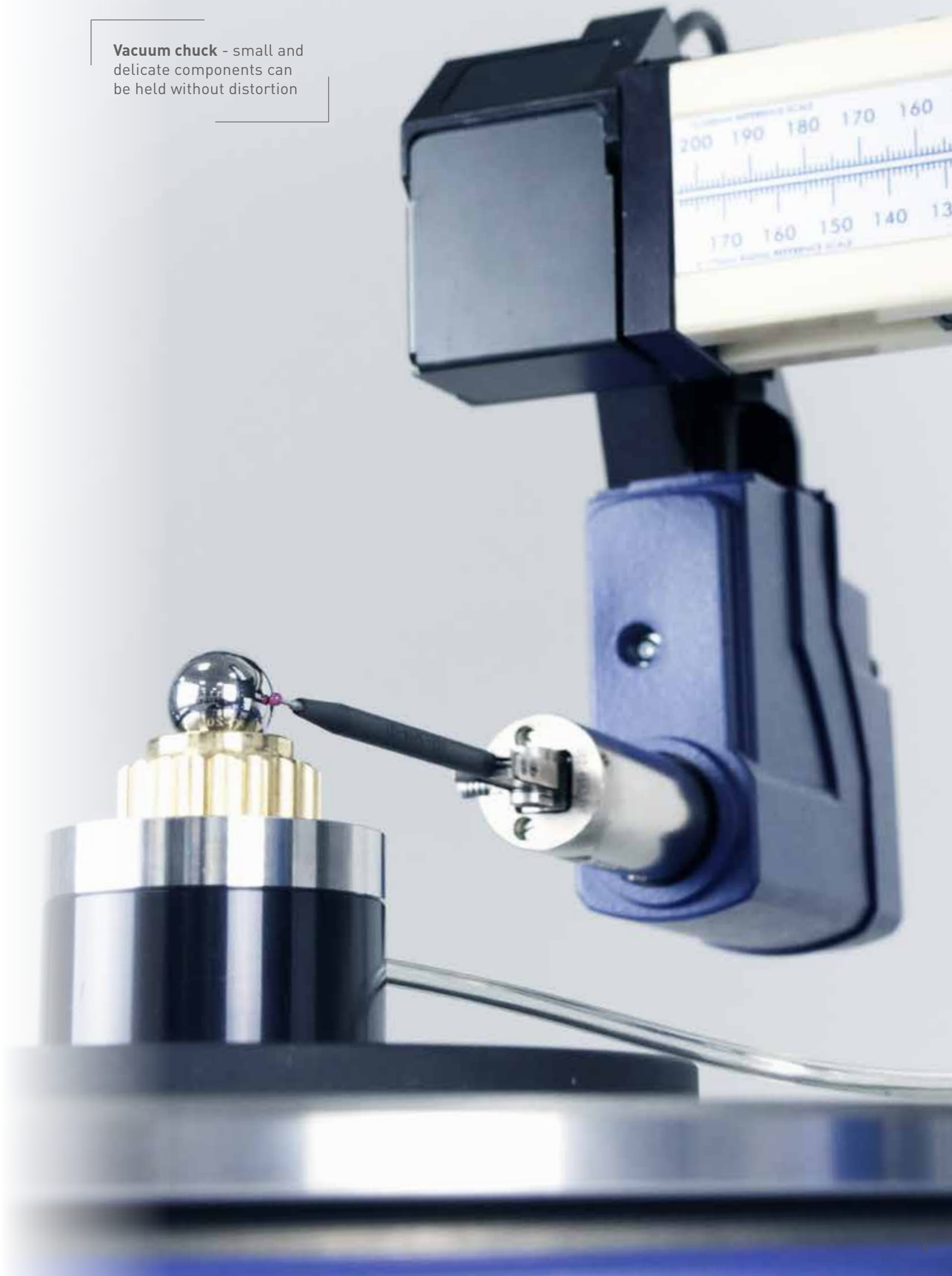

AUTOMATION

Precise and fast instrument control

✔ Multi-part carousel stage

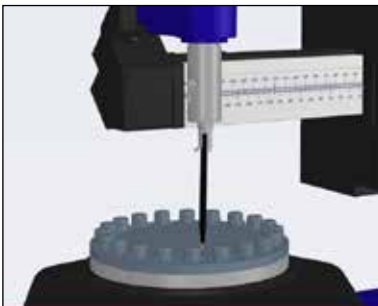

The rotary stage has a unique counterbalanced design ensuring measurement without any loss of accuracy. Simple control is provided via our Metrology 4.0 Production Interface, enabling complete automated measurement of up to 20 parts.

This makes the Talyrond® 595 HS PRO ideal for the measurement of small components in the bearings, optics, medical and automotive industries.

✔ SMART Move and CAD models

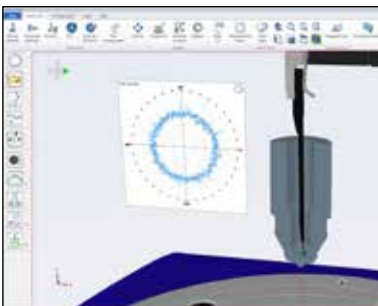

A powerful utility that enables online and offline programming around a CAD model. Features include a stylus tip “flight path” enabling collision detection.

The Metrology 4.0 visual display is an exact replica of the real instrument; seeing is believing. Measurements are made between pre-defined points or from points fed back from the analysis process. Improved accuracy and repeatability can be achieved via the unique feedback process.

✔ Crutch angle correction and automatic gain calibration

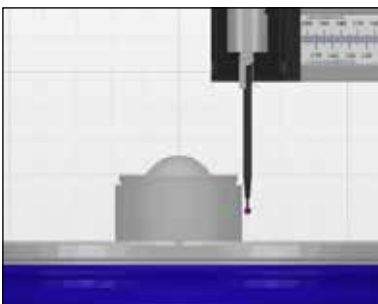

A simple approach to gauge calibration that literally takes seconds to do. Utilising the instrument high precision scales this procedure calibrates both the gauge gain and crutch angle position in a single user guided operation.

All subsequent movements of the gauge attitude orientation are updated to ensure corrected stylus tip position between the virtual and real instrument.

Talyrd® 595 HS PRO -
Designed for metrology
without compromise



SMART

So much more than a roundness instrument

☑ Centre & level

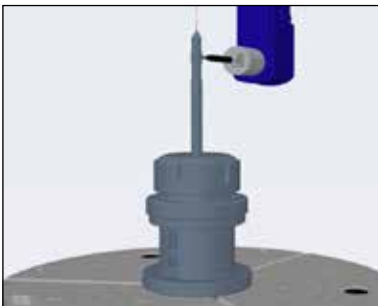

Another first is the unique three-point centre and levelling method which provides a stable and high-load capability.

Precise positional control combines with predefined alignment positions to produce the fastest centre and levelling device on the market.

This feature is ideal for high production volume environments where fast feedback is critical.

☑ Automated axis calibration



A simple automated routine that allows the user to set all axis positions without manual entry, removing operator error and ensuring positional consistency when programming.

☑ Follow mode



Follow mode is possible using the Radial Straightness Unit, this ability to track the surface of the part allows measurement of tapers, splines, camshafts, CV joints and much more.

Comprehensive analysis can be made on circular or straightness profiles utilising the powerful Advanced Contour software.

Centre and Level -
Completed in less
than half the time



SOFTWARE

Best-in-class metrology software

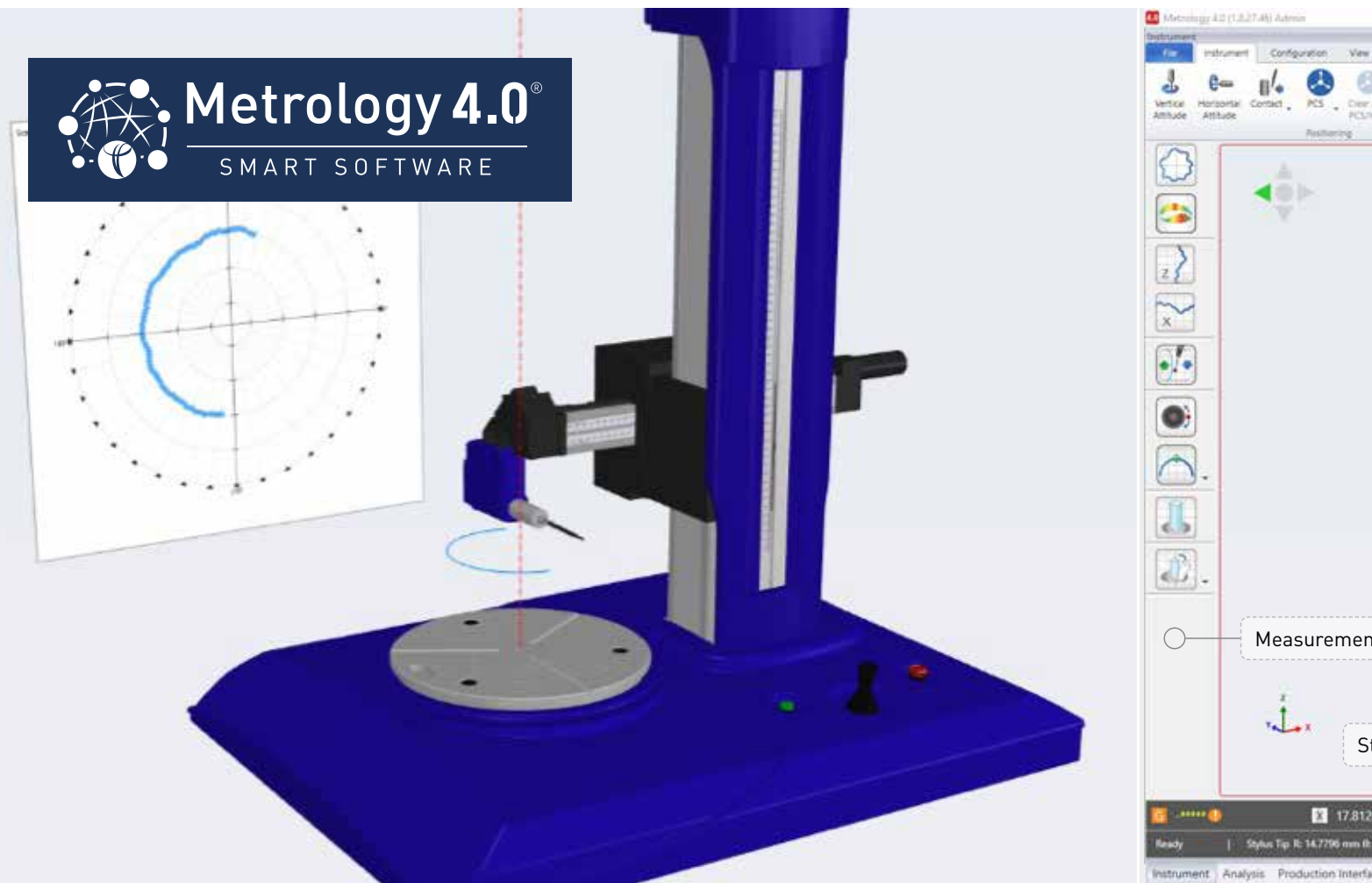

✔ Part Co-ordinate System

Metrology 4.0 has two co-ordinate systems; instrument and part.

The Part Co-ordinate System (PCS) allows the user to control measurement and movement around any component according to the part drawing.

The on-screen view provides an exact simulation of the real instrument, allowing remote monitoring and at a glance confidence in the measurement process.

✔ Calibration

One hit patented calibration routines provide accurate and precise measurements.

These routines are fast and do not require operator intervention ensuring maximum performance.

Media Messages - Include text, images and videos as operator prompts during programs

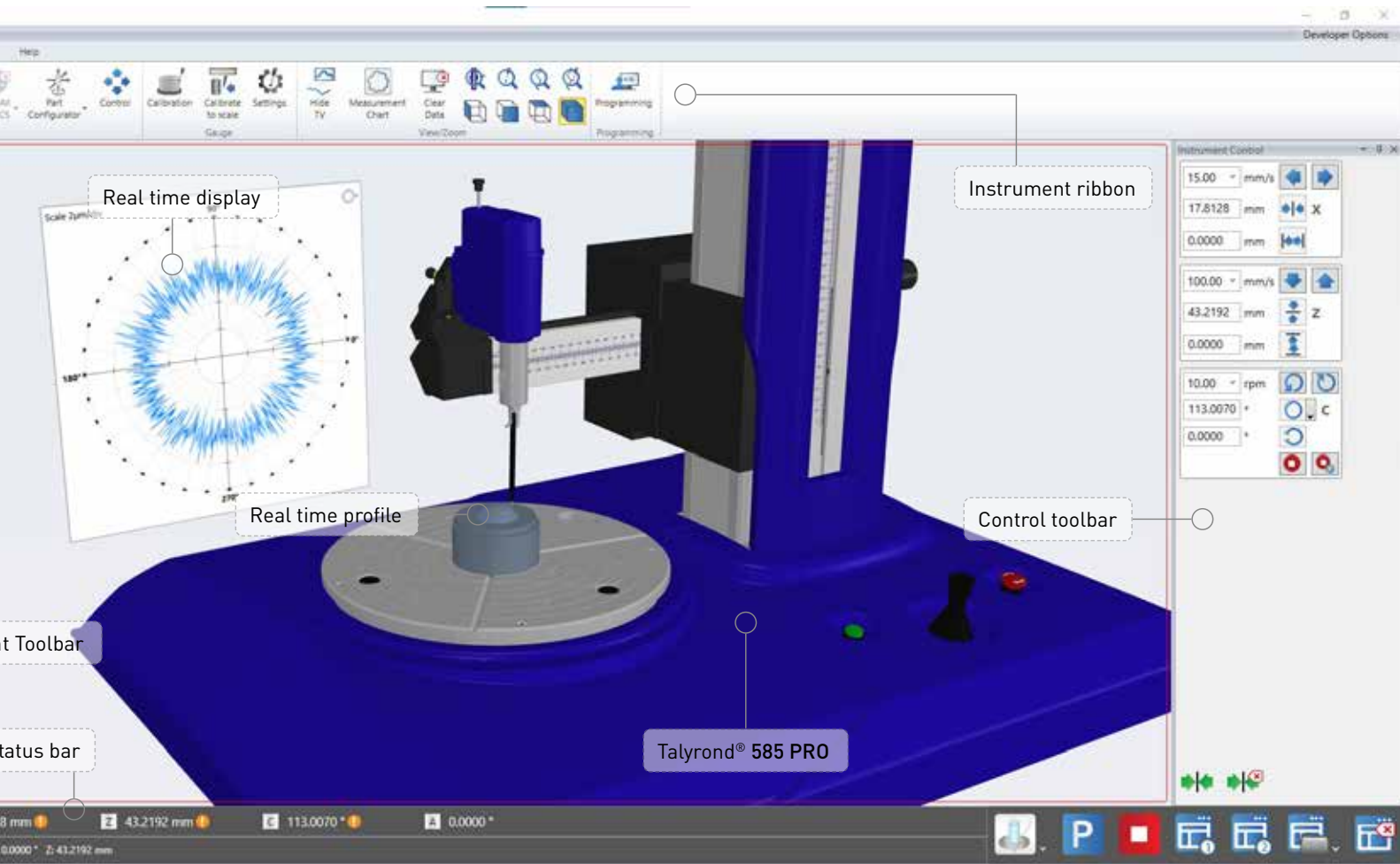

✓ Programming

A range of different modes that offer basic elements such as recordable part programming and an advanced toolbox of programmable features including variables.

The use of variables reduces the time it takes to create and maintain multiple part programs. This function allows one program to be created for a set of parts of differing sizes.

✓ Macros

A new software feature that enables the user to define icon-based functions. These functions can be set to run custom measurement programs, media messages, instructions, warnings, calibration routines, and much more.

The user has instant and configurable access to all macro functions directly from the instrument control ribbon.

SOFTWARE

Designed with the operator in mind

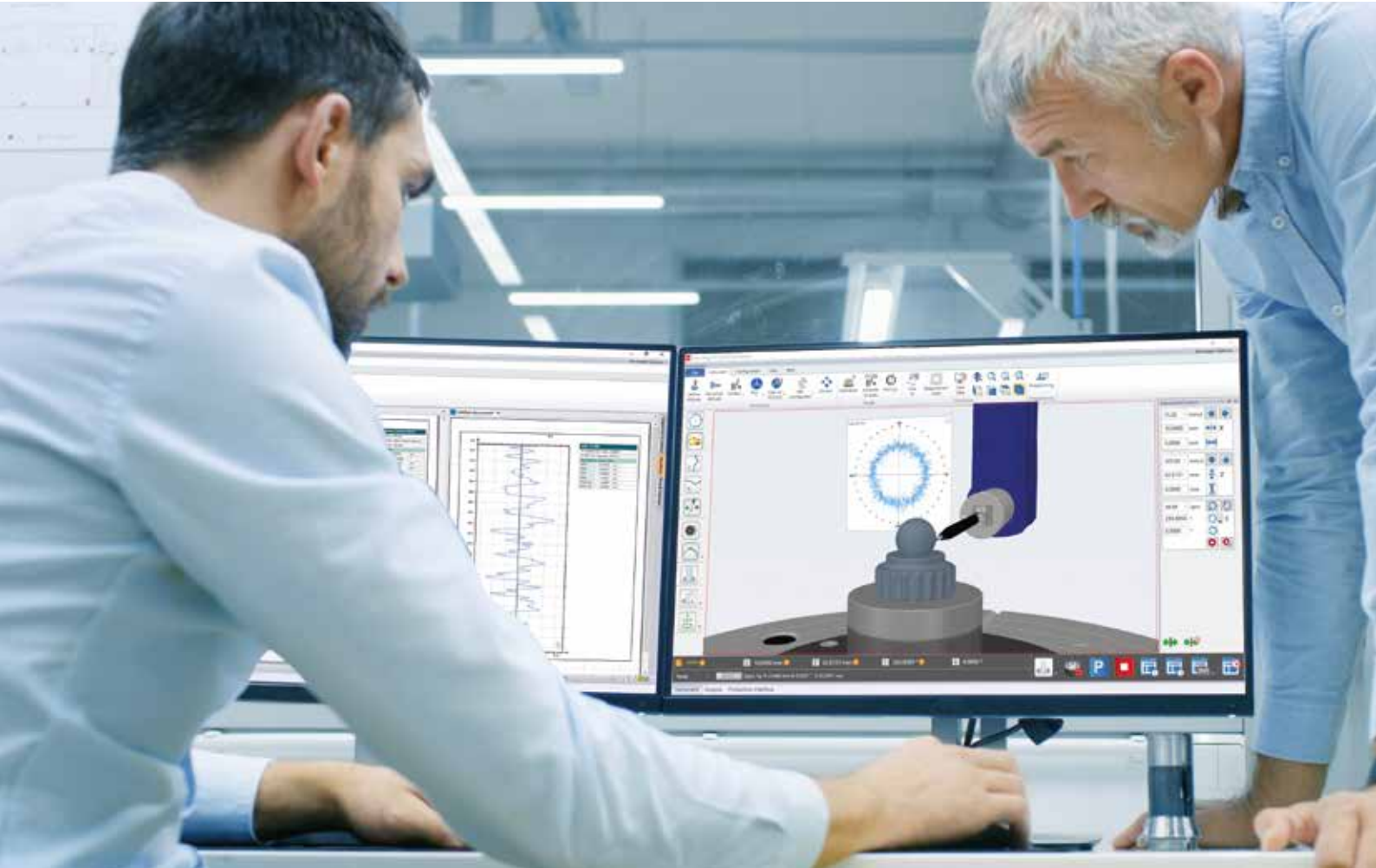

SMART Move

Simply click on the screen to create a point and the instrument will then move the stylus tip to that point. The instrument moves using either the traverse, column or a combination of these axes. A pre-flight path allows the user to predict and control the axes of movement to avoid any obstructions.

Measurements are made between pre-defined points or from points fed back from the analysis process. Improved accuracy and repeatability can be achieved via the unique feedback process.

- Program around CAD models
- Collision Prediction
- Pre-flight path visualisation
- Simple click and move to position
- Fully programmable
- Define part coordinates from measured features

SMART Move - A perfect tool for online and offline programming

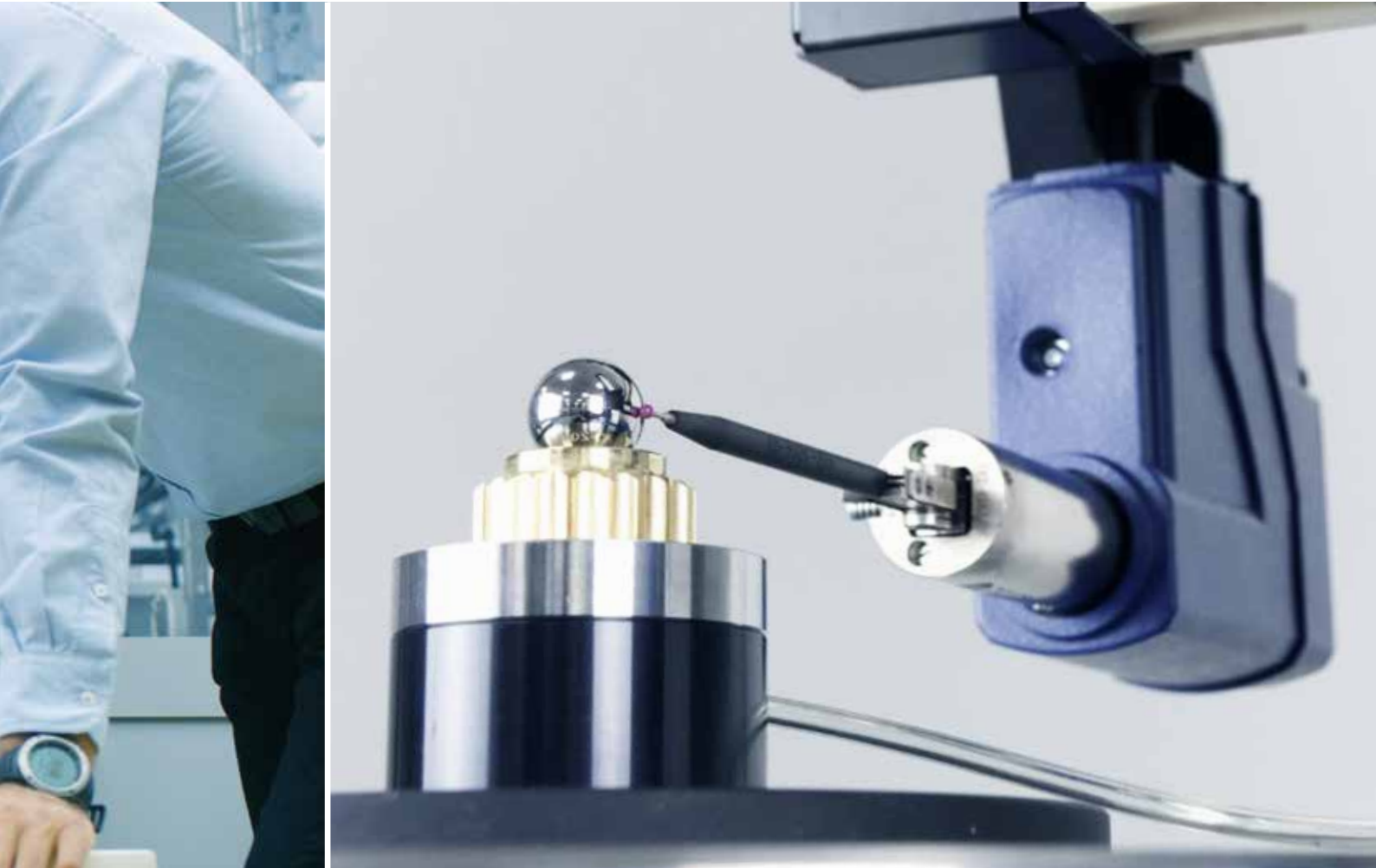

✔ Icon-driven interface

Metrology 4.0 enables simulation of the measurement process with 'at-a-glance' status, on-screen indicators, real-time feedback and remote system control.

A range of different measurement modes are available via intuitive icons on the measurement tool bar. Tool tips give a detailed overview of the measurement.

✔ User levels

The password protected modes provide complete control of a user's access, resulting in a tamper-proof software interface for use in the most secure environments.

The interface can be tailored to suit all skill levels from basic to advanced users by simply disabling or enabling access to functions and features.

ANALYSIS

One software platform, multiple disciplines

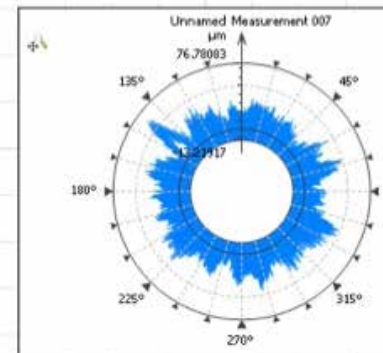
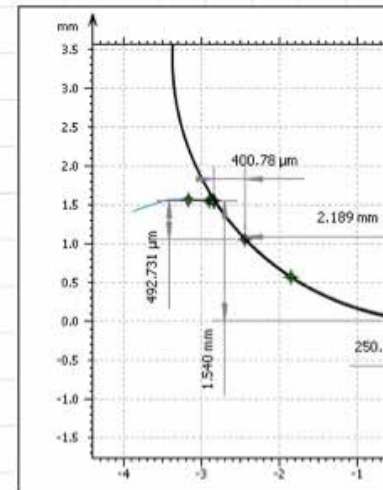
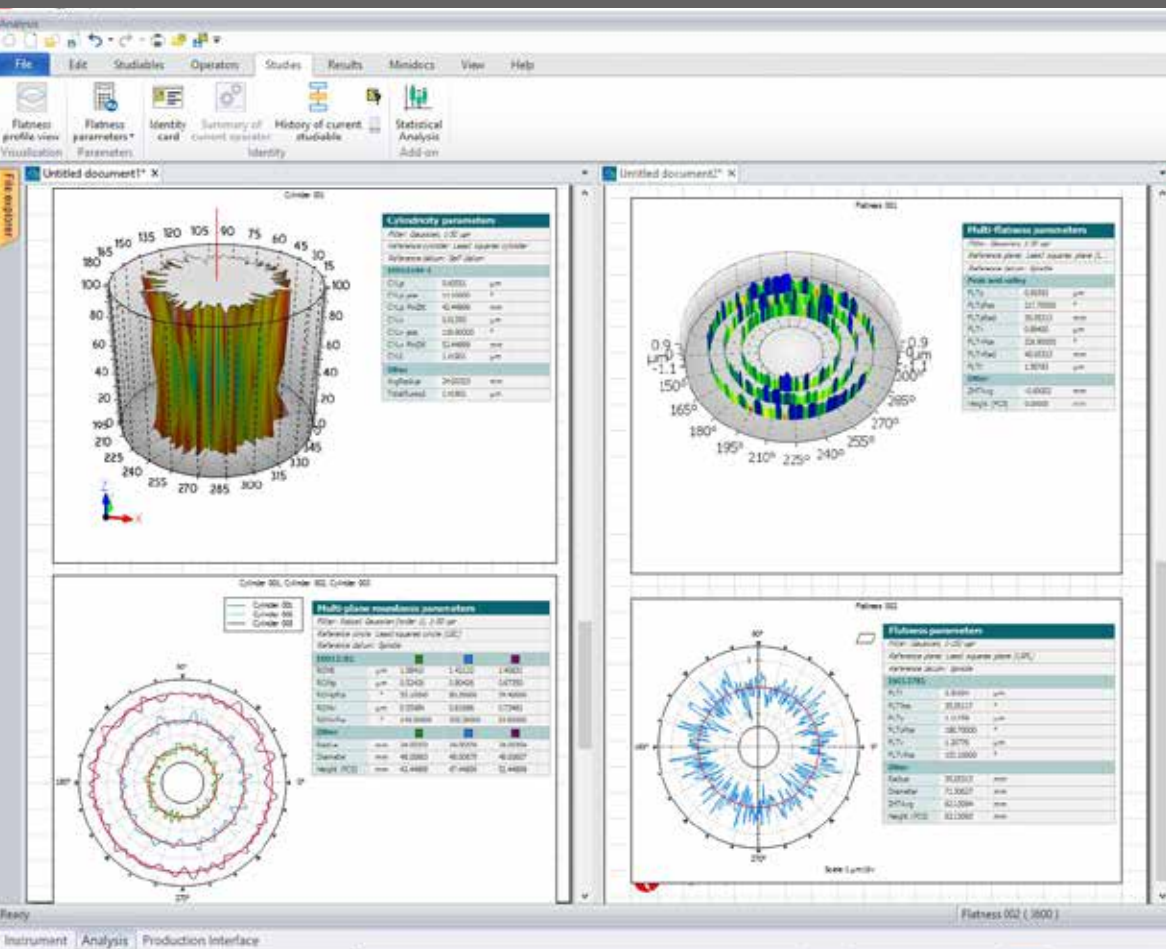

Roundness

A complete roundness system capable of cylindricity, flatness, straightness, parallelism and much more.

Contour

An essential tool for geometric dimensioning, tolerancing of profiles and full form deviation analysis.

Save time and increase productivity with automation features within Contour analysis.

Topography

Transform your 2D measurement into a powerful 3D analysis to view the surface in greater detail using Metrology 4.0 Analysis 3D software.

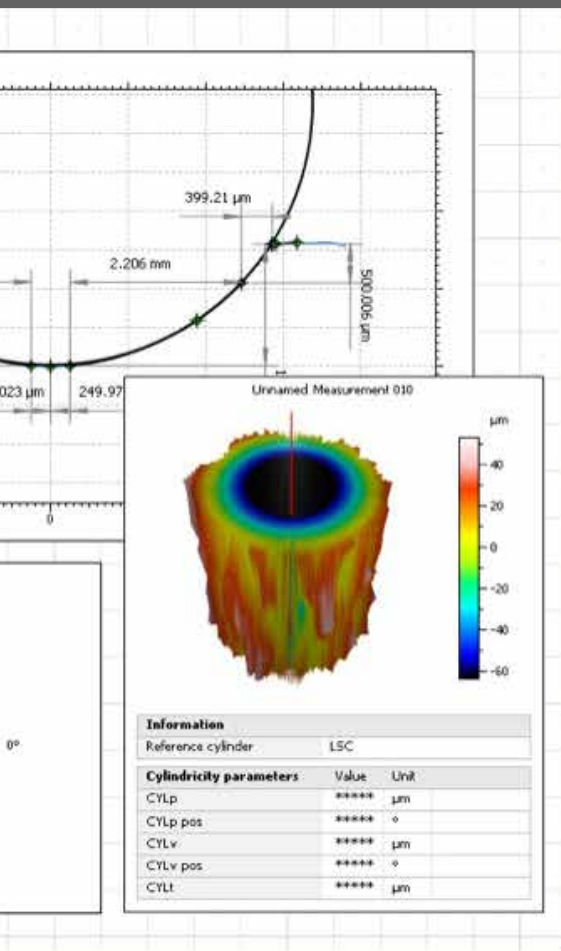

Crown Long In Contact 20	
ASME B46.1 - Roughness profile (S-L)	
<i>F: Leveled (LS), Angle -0.00304°</i>	
<i>λz Filter: Gaussian, 2.5 μm</i>	
<i>λx Filter: Gaussian, 0.8 mm, 1/2 cut-off</i>	
2D parameters	
Rt	1.30309 μm
Rp	0.23152 μm
Rv	1.07157 μm
Rz	0.56448 μm <i>Alt Ac (29)</i>
Ra	0.05886 μm
Rq	0.08448 μm

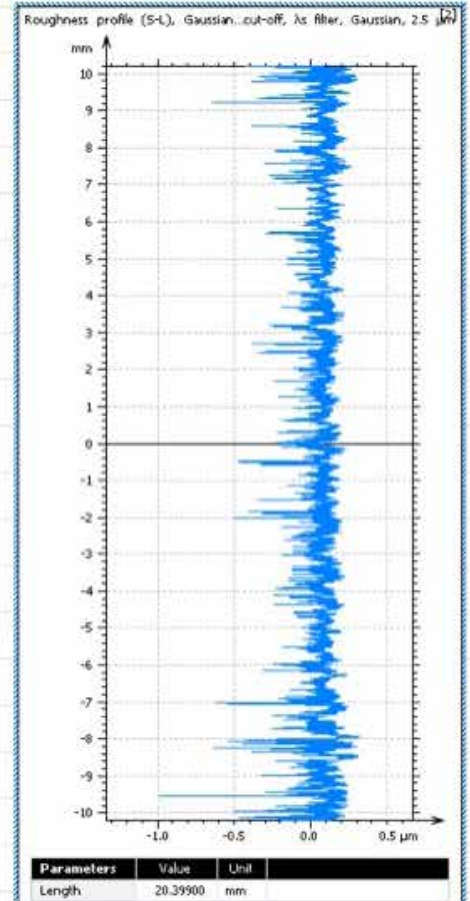
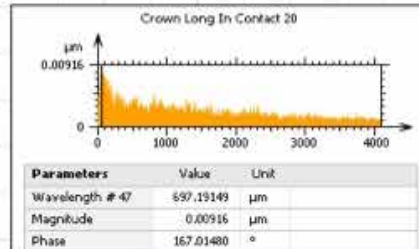
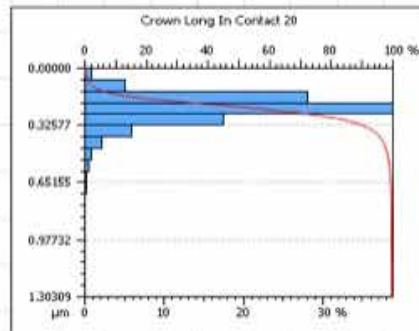

✓ Surface texture

The Talyrond® 595 HS PRO has the lowest noise platform and the highest resolution gauge, enabling roughness measurement to a level normally associated with surface texture instruments.

✓ Critical analysis types

- Twist measurement
- Harmonic analysis
- Velocity analysis
- Ballscrew measurement
- Wall/disc thickness
- Cam measurement
- Angle measurement
- Dual profile
- Data fusion
- Circumferential surface texture
- Profile patching

DESKTOP PUBLISHING

Quick, simple and professional

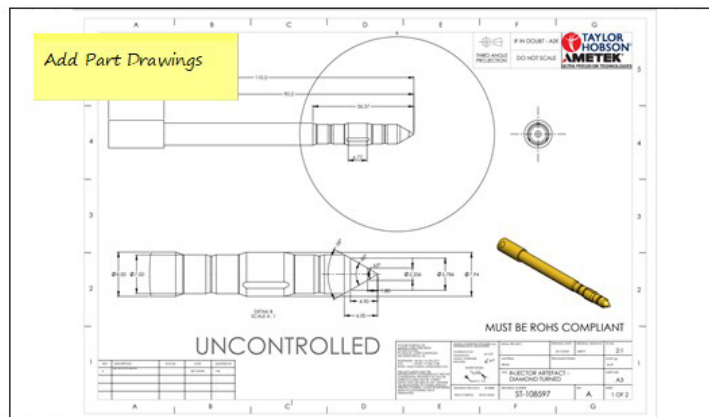
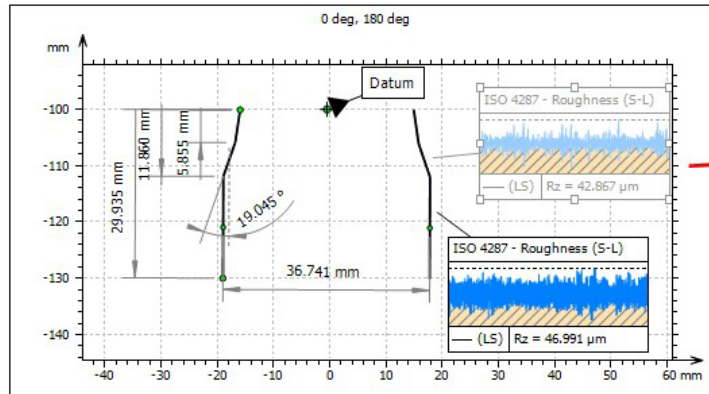
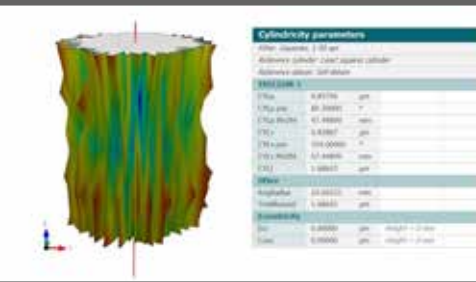
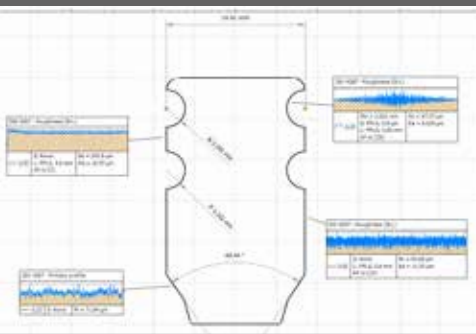

Metrology 4.0 Analysis 8.2.9570

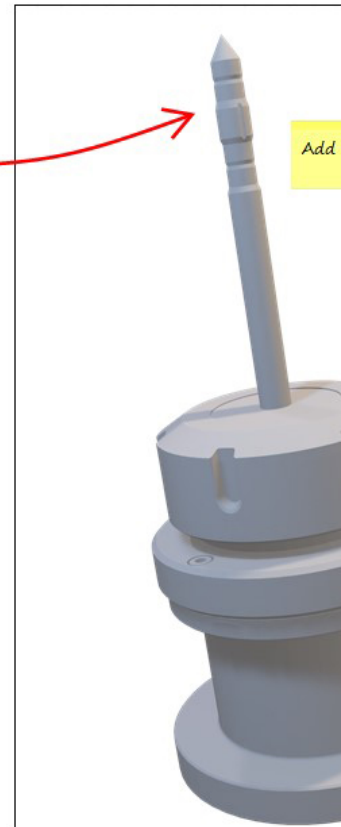

✓ Desktop publishing

The desktop publishing features are powerful and simple to use allowing customisation of result layouts and ensuring a more professional and personalised look to your brand.

The software allows users to create templates and use them in the analysis process, which vastly simplifies the measurement process.

- Generate interactive reports
- Compose multi-page documents
- Multiple documents can be displayed on screen, which enables visual comparison of multiple results at once
- Build a professional report in a matter of minutes
- Include corporate logos
- Create certificates



Customised analysis

Our strategy for success is simple, instead of just selling products, we provide solutions. If our standard software analysis packages do not satisfy your needs, we can customise a solution to match your requirement as an advanced module.

Alternatively Metrology 4.0 has built-in access to execute MATLAB™ files*. This enables the user to writing their own scripts and execute them by loading an 'm' file.

Design and program your own custom filters, analyses and parameters.



Professional Desktop Publishing

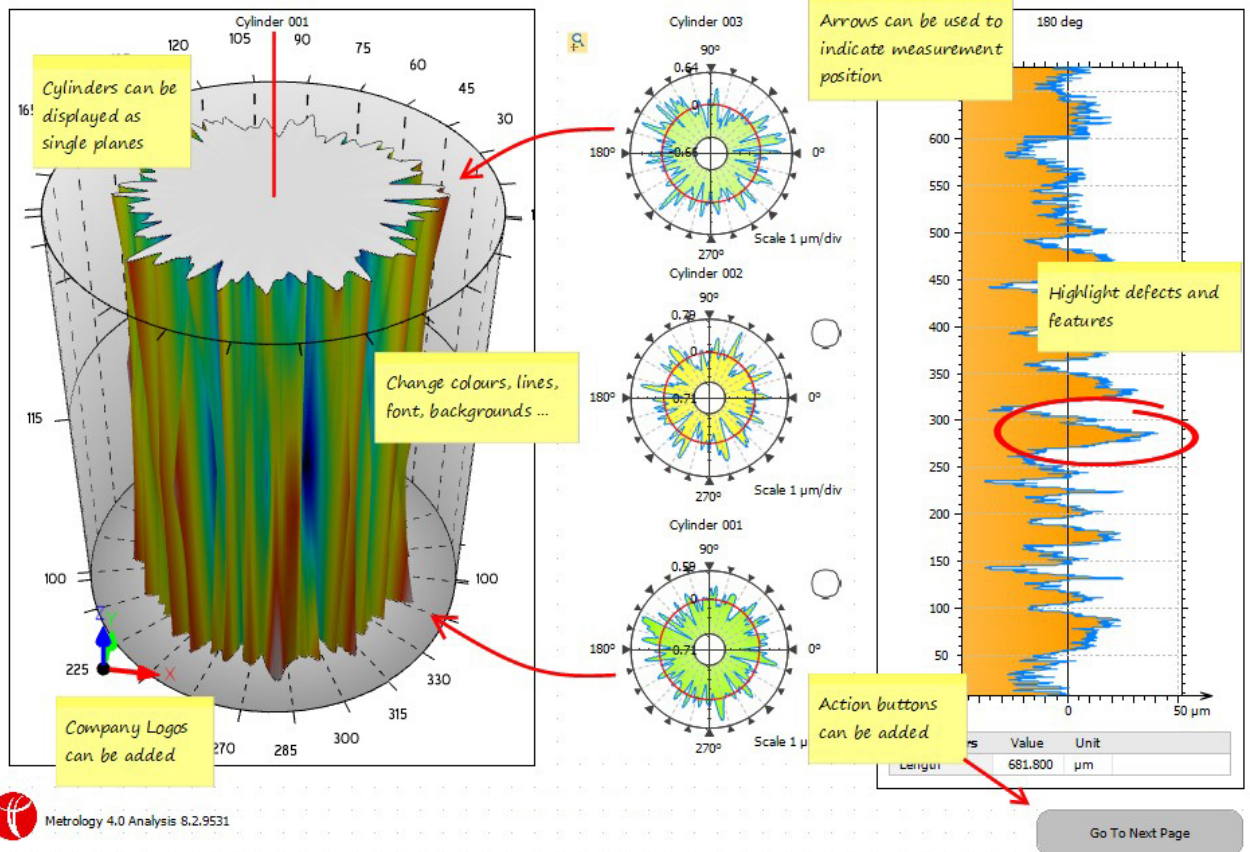

Feedback measurement control

Repeatability and reproducibility are key to any production process. Metrology 4.0 closes the loop between measurement and analysis by feeding back positional information to the movement or measurement process in order to improve process control.

Repeatability and reproducibility are key to any production process; the same is true for the measurement process.

Movements and measurements can be controlled by defined features on a part such as intersections.

- Measure profile
- Create datum points for critical features
- Add datum points to instrument view
- SMART Move to start position
- Measure between specified points
- Apply template to the analysis

* MATLAB™ software purchased separately from external source.

APPLICATIONS

Unparalleled measurement capability

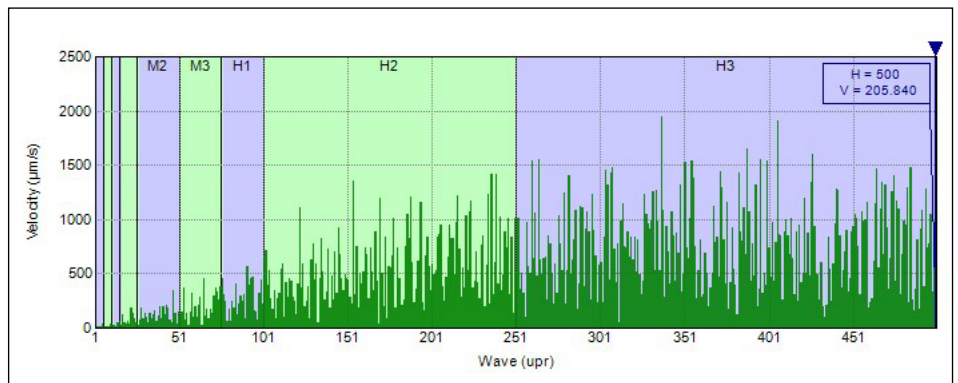
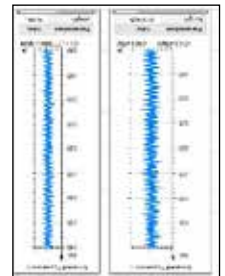
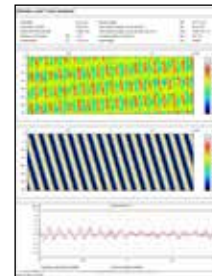
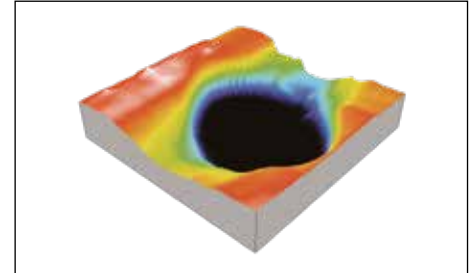
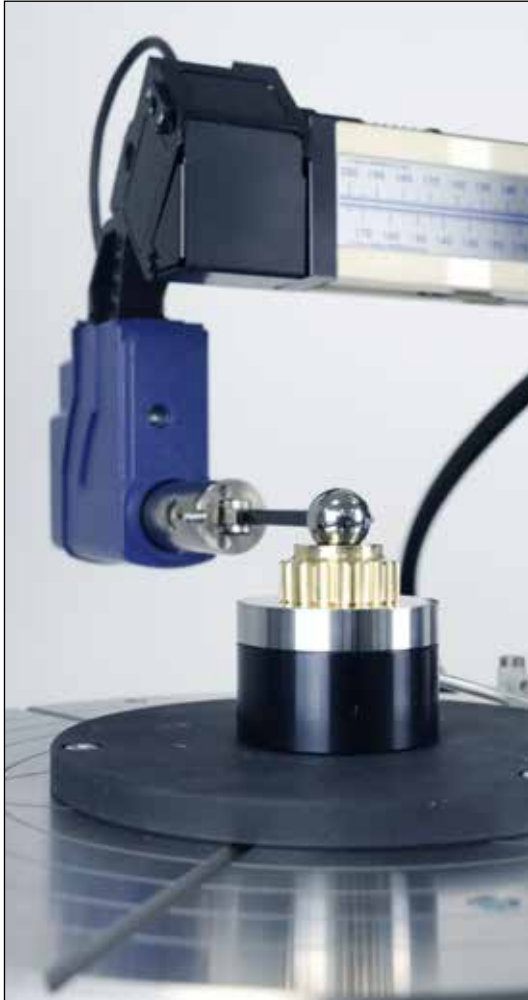

✓ Ball bearings

Electric Vehicle technology and the drive for efficiency and lower emissions have had a huge influence on bearing manufacture.

In order to achieve these criteria, bearings are becoming more precise, pushing the boundaries of instrument capability.

The Talyrond® 595 HS PRO has the lowest noise floor on the market however the instrument's new high precision mode will reduce the noise even further ensuring high integrity results for Harmonics, Velocity and surface finish measurement.

The optional vacuum fixture enables small and delicate components to be held without distortion delivering greater measurement access by removing the need for direct clamping. The vacuum chuck has no effect on roundness, noise or any other influence on the measurement process.

Precise components such as ball bearings can be measured with full confidence in results. The portable vacuum chuck base can be removed to accommodate larger parts or parts that do not require the vacuum.

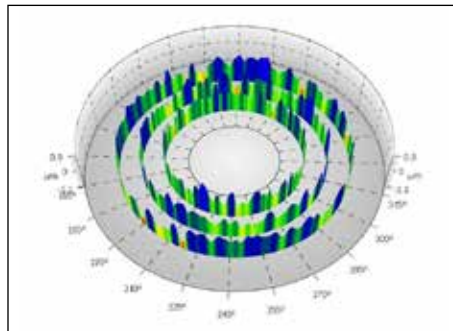
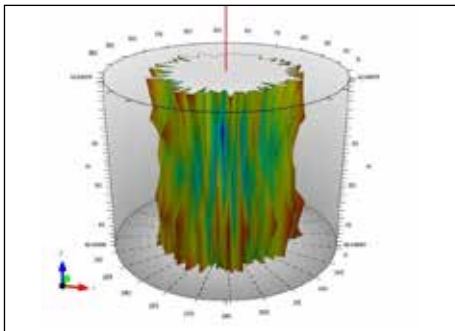
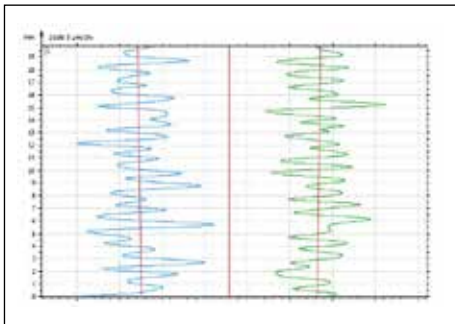
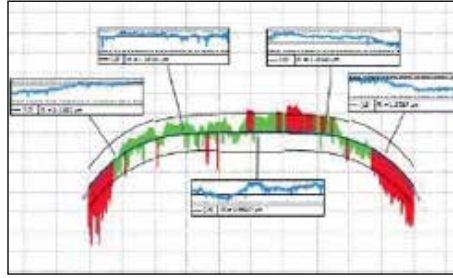

✓ Roller bearings

Complete automation of multi-part measurement, provides cost effective, high volume throughput

The optional rotary stage transforms the Talyrond® 595 HS PRO into a multi-part measurement system. This portable device simply sits on the spindle table via three point location and plugs into a concealed socket.

The rotary stage has a unique counterbalanced design ensuring measurement without any loss of accuracy. Simple control is provided via Metrology 4.0 software interface, enabling complete automated measurement of up to 20 parts.

This makes the Talyrond® 595 HS PRO ideal for the measurement of small components in the bearings, optics, medical and automotive industries.

Low noise, precision straightness and the high-resolution gauge of the Talyrond 595 HS PRO enables measurement of roller bearings.

This allows control of roughness, form, and roundness as well as providing part alignment information relating to the machine tool such as tilt, parallelism and offset.

APPLICATIONS

Buy with confidence

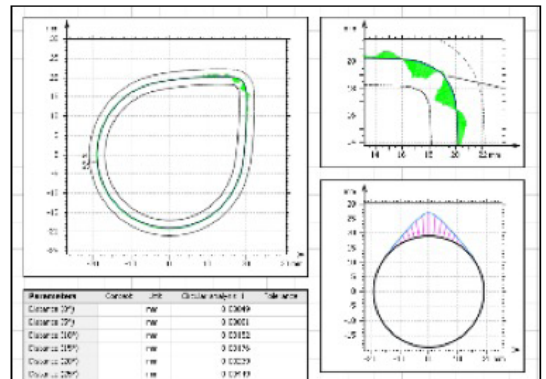
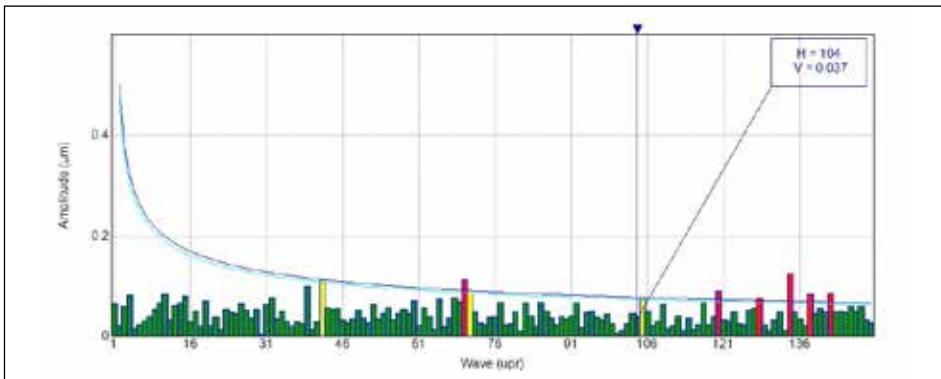
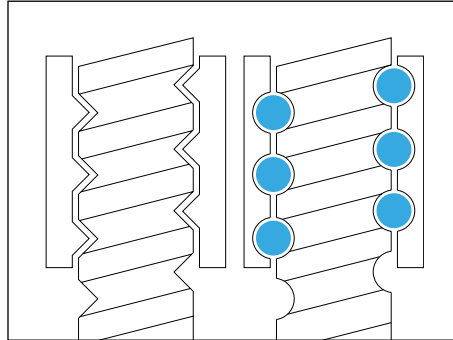

✓ Ball screw

The Talyrond® 595 HS PRO provides measurement along the full length of the contact point of the ball screw or lead screw.

High precision control and low noise on all the instrument's axes enable analysis of harmonics and roughness and help towards ensuring smooth operation of the ball screw.

✓ Camshafts

The instrument's radial straightness unit and high precision spindle allow measurement of a cam profile. Subsequent analysis can be done using Taylor Hobson's Advanced contour software, enabling comparison to a DXF or lift data.

Other features of the contour software include surface texture and harmonic analysis.

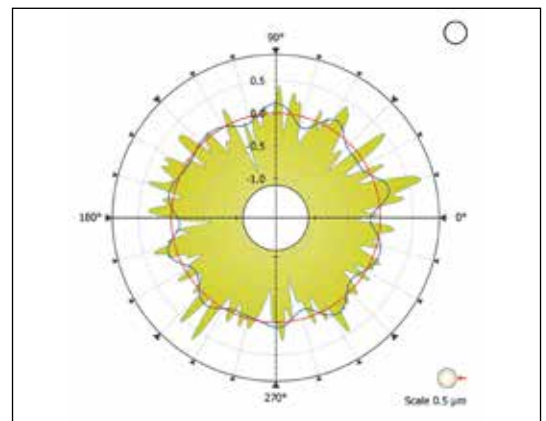
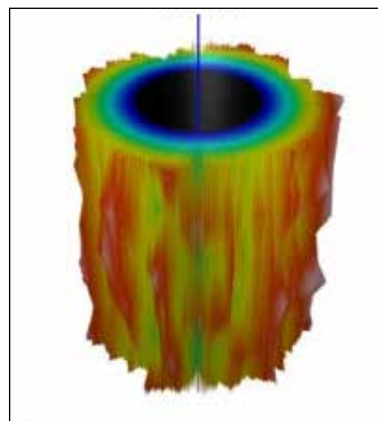
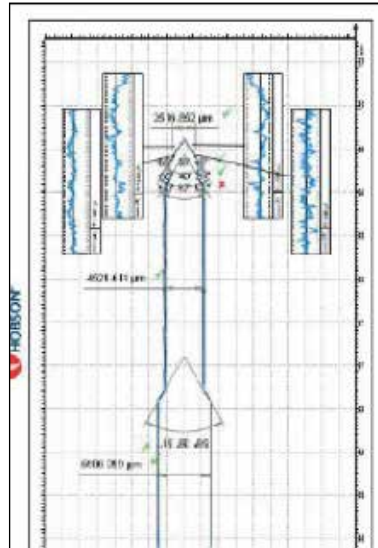

✓ Fuel injectors

Measurement capability normally associated with the Form Talysurf[®] PGI NOVUS such as seat angle, seat surface texture and seat straightness can be evaluated along with standard parameters such as parallelism, straightness, roundness, runout and much more.

✓ Bearing races

The Talyrond[®] 595 HS PRO frictionless air bearing spindle has been developed to allow measurement of roundness and just as importantly harmonic analysis.

In fact every Talyrond 595 HS PRO[®] is extensively tested for harmonic noise to ensure results are from the part and not induced by the instrument.

TRACEABILITY

Critical results, trust Taylor Hobson

Full traceability to international standards

Taylor Hobson provides full certification for artefacts and instruments in our purpose built ISO graded clean room UKAS facility.

Our UKAS laboratory is able to measure all of the parameters associated with surface texture, including French, German, USA and Japanese derivatives.



✓ Roundness

Using a precision polished glass hemisphere calibrated to an uncertainty of less than 5 nm Taylor Hobson can guarantee your spindle is within specification and maintain quality of results.

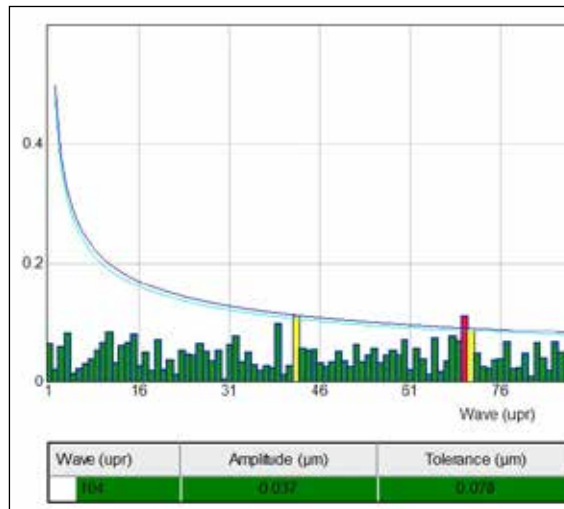

✓ Surface texture

A unique standard is available that provides measurement traceability for roughness in both a vertical and circumferential direction.

✓ Contour

Taylor Hobson's patented calibration routine and calibration ball corrects for the arcuate motion of the stylus allowing dimensional measurement.

This routine is critical to measurement of radius and angled parts when normal calibration routines will not suffice.

✓ Harmonic standard

Taylor Hobson are the only instrument manufacturer that offer a harmonic standard with harmonics from 15 - 1500 upr.

This standard gives you confidence in your results.



0026

2624



Automated probe calibration

The Talyrond® 595 HS PRO has a unique automated gain calibration for the instrument's gauge; the routine is automated and takes a matter of seconds to set.

Alternatively a set of calibrated slip blocks traceable to primary standards are also supplied.



Straightness, squareness and parallelism

To ensure the column and radial straightness unit conform to specification we can provide standards that are either cylindrical or flat. These standards provide certainty of the measurement axes.

These artefacts are combined with special software routines to enhance all axes for correct geometrical form.

