

Form Talysurf® PGI NOVUS

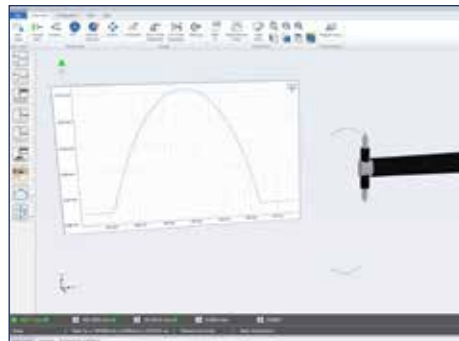

The most advanced system for surface finish,
contour, 3D and diameter measurement

Form Talysurf® PGI NOVUS

The New Form Talysurf® The New Original.

Introducing, the most advanced system for surface finish, contour, 3D and diameter measurement.

At the heart of the new Form Talysurf® PGI NOVUS is a ground-breaking dual bias gauge.

The NOVUS gauge provides the ability to measure diameter; included angle, surface finish in a normal and inverted direction with the same speed and accuracy.

Through this development, Taylor Hobson has addressed challenges faced day-to-day by bearings, injectors and precision component manufacturers.

Buy with confidence.

When you purchase from Taylor Hobson, you are investing in the most accurate, stable and repeatable measurement system on the market.

The Form Talysurf® PGI NOVUS delivers class-leading:

- Angle
- Radius
- Range
- Diameter
- Form
- Resolution

Unique benefits for both design and production.

One measurement, multiple results, instant feedback.

Surface finish - High resolution gauges with low noise enable roughness, waviness and form in one measurement.

Contour - Our patented calibration technique enables measurement of radii, angle, height, length, distance and more.

Topography - Using an optional motorized Y-stage and Metrology 4.0 software, transform your conventional 2D measurements into 3D.



Industry 4.0 - Smart Factories.

The future of modern manufacturing.

Industry 4.0 philosophy is driving what has been called a 'Smart Factory' through the process of automation, data exchange and control in manufacturing environments.

A "Smart Factory" includes a variety of modern technologies such as, Internet of Things, Internet of People, Cloud computing, Smart sensors and Advanced SPC software.

Taylor Hobson's ongoing developments support this approach and are in line with the Industry 4.0 philosophy.



Metrology 4.0

SMART SOFTWARE

In so many ways, it's a first.
Advanced metrology, made simple.



SMART Move in action

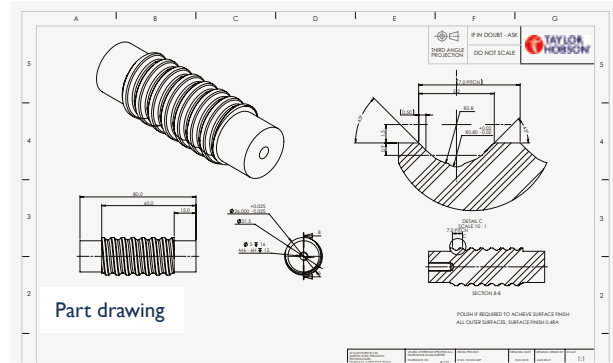

Part drawing

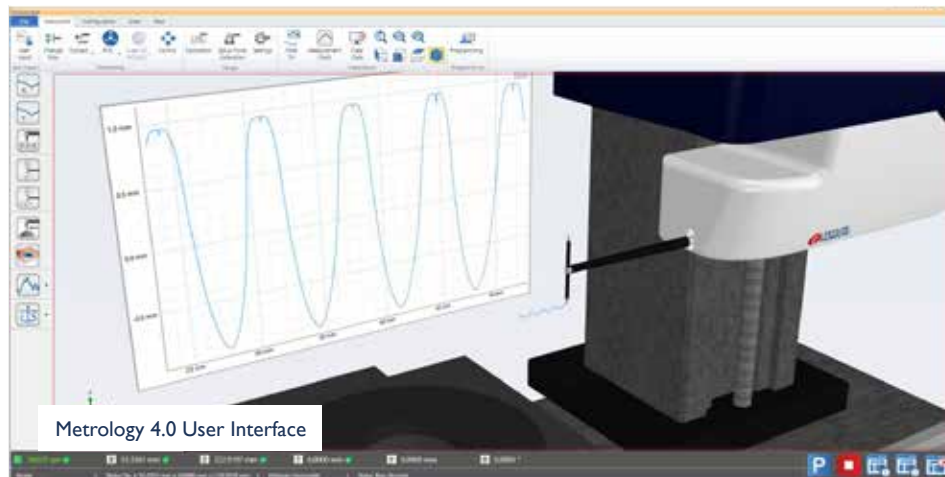

Metrology 4.0 User Interface

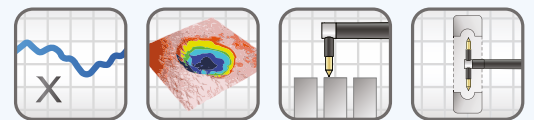

Metrology 4.0 - Smart Software.

Cutting-edge technology.

The advancement in metrology software design that the market has been waiting for...

Taylor Hobson's new advanced software enables dimensioning in accordance with part drawings and provides an exact reflection of the Part Coordinate System (PCS) providing the final link in the manufacturing loop.

Metrology 4.0 delivers a simple, intuitive interface with virtual display and real time control. The state-of-the-art point and move axis control function (SMART Move) delivers precise positioning and measurement with ease.

Operator benefits.



Virtual display - simulation of the measurement process with 'at-a-glance' status, on-screen indicators, real-time feedback and remote system control.



SMART Move - intuitive operation for moving and measuring. Once a part has been set-up, the user can then zoom to a detail that the eye cannot see and program around the virtual part.



Variable programming - enables users to automate measurements of a multitude of part sizes without the need for a multitude of programs.

SMART Factory

The future of modern manufacturing. **Industry 4.0 supported by Metrology 4.0**

Forward thinking.

Metrology 4.0 software includes an intuitive, easy-to-use and modern production interface.

The QDAS accredited production interface is designed for shop floor environments and provides direct communication with SPC software, which delivers feedback to your manufacturing process.

This form of monitoring is used widely in automotive and aerospace component manufacturing, where data and strict standard operating procedure control is mandatory.

User benefits.



Programs reduce operator mistakes.



Programmed measurement routines reduce cycle times and increase throughput.



Display traceable pass/fail results and automatic summary reports.



Historic traceability is made possible via data exchange and part tracking.



Control can be managed by barcode scanners or tracking/auditing system.



Statistics such as automatic R&R studies.



Tolerancing - Visually identifies the parameter and tolerance band.

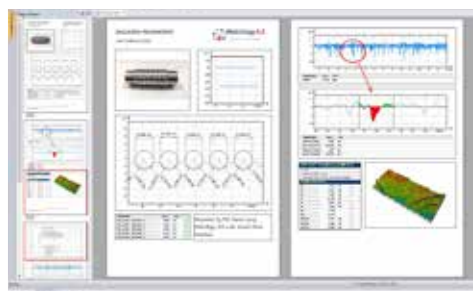
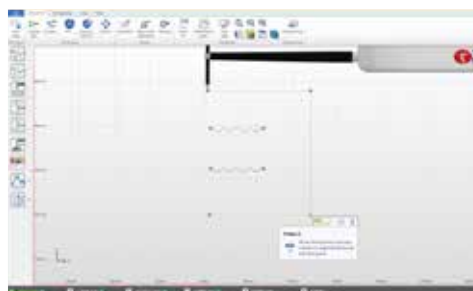

Remotely monitor results in Metrology 4.0 production interface

Taylor Hobson metrology directly monitoring production. Modern manufacturing cycle.

1. Innovative design.
2. State-of-the-art manufacturing.
3. Fast and automated part-handling.
4. Measurement and analysis powered by Metrology 4.0
5. Feedback of results to data centre for trend analysis.
6. Monitor trends in the field or in production.
7. Improve quality and efficiency.

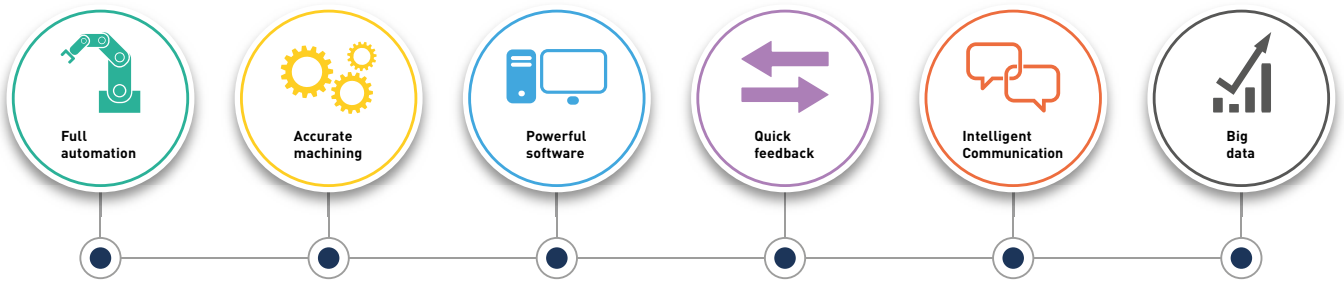

Industry 4.0 in action.

All of the critical components for the Form Talysurf® PGI NOVUS are manufactured in-house at our UK facility, with unique serial numbers for worldwide traceability.

Taylor Hobson have invested in the latest machining techniques to deliver measurement integrity through manufacturing excellence.



"Our strong investment meets the demands of high technology manufacturing"

Tim Garner, Operations Director.
– Taylor Hobson Ltd.

Taylor Hobson's latest investment includes the Mazak Integrex i-200S with 10 axis, twin spindle, in cycle probing, tool break detection, unmanned running, temperature control, zero set up times, auto re-loading, high accuracy glass scales and 110 tool capacity.

Form Talysurf® PGI NOVUS

The New Form Talysurf® The New Original.

Complete trust in
your measurements
and results.

Fundamental to any metrology system is the integrity and reproducibility of the results it delivers.

The foundation of accurate measurements is the system's noise floor capability. Taylor Hobson take great pride in boasting the worlds best noise floor.

Our product design is underpinned by decades of measurement experience, ultra-precision manufacturing expertise and FEA optimised design.

These attributes provide low noise and near flawless mechanical execution of the measuring axes.



World-leading range with the PGI NOVUS gauge.

The Form Talysurf® PGI NOVUS delivers 20 mm gauge range with a standard 100 mm stylus.

The PGI NOVUS gauge has been designed to provide the user with greater measurement flexibility. Small, medium and large complex parts can be measured on a single system.

Buy with confidence and future-proof your investment. Using a 200 mm stylus provides an industry-leading 40 mm gauge range with full surface finish capability.

Verification of system measurement accuracy.

Taylor Hobson is the only company that can prove radius accuracy and form capability over the **full** gauge range.

This is to certify the integrity and reproducibility of the results the system produces.

Other manufacturers quote less radius accuracy and form capability over a significantly reduced gauge range, indicating less confidence in their measurement results.

Diameter & angle capability with reverse bias gauge.

The dual bias NOVUS gauge combined with the new high precision column delivers unparalleled diameter measurements to sub-micron accuracies. This capability is critical to manufacturers of components such as bearings, injectors and ball screws.

The above attributes coupled with the instrument's ability to measure internal or external angle make the Form Talysurf® PGI NOVUS a truly versatile system.

Gauge Range

20 15 10

Gauge range, up to
20 mm

Resolution

S E C

Resolution, down to
0.2 nm

Bias

▲ ▼

Bias options
Dual or single

Software



Powered by
Metrology 4.0

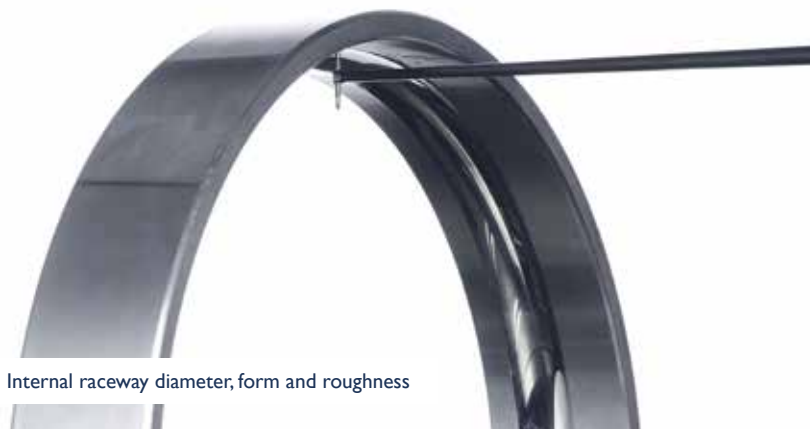

Internal raceway diameter, form and roughness



Reverse bias for PCD analysis along with gothic form and dimensions

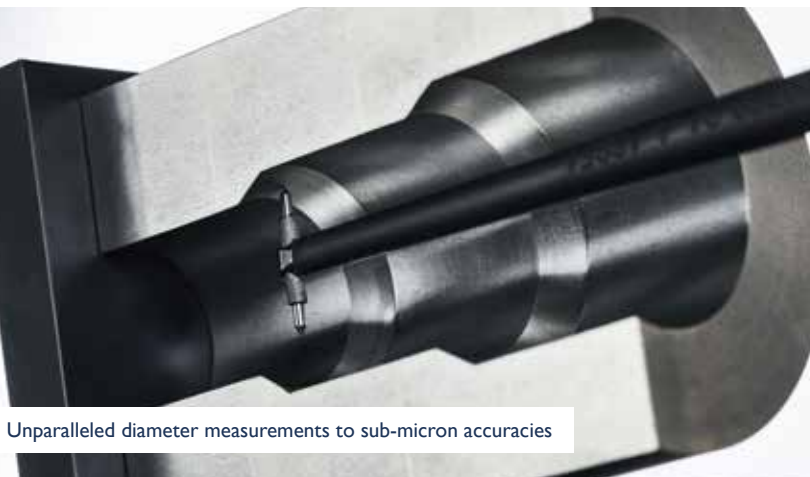

Unparalleled diameter measurements to sub-micron accuracies



Easy access to gear teeth using dual tipped small bore stylus

Automated force control to ISO standards.

The PGI NOVUS gauge maintains an ISO recommended tip pressure of <75 mgf while using a 200 mm stylus with 2 µm diamond tip.

- Force control is automated and maintained throughout the measurement cycle.
- For softer materials, the stylus force can be adjusted to as low as 30 mgf.
- Automated force control adheres to ISO standard 3274.

Automatic lift-lower.

The precise lift-lower function minimises gauge movement and reduces the measurement time while also providing safe and automatic clearance of the part.

Coupled with closed loop feedback, the lift-lower excels during many different modes of measurement:

- Batch.
- Discontinuous (interrupted features).
- Diameter.
- Internal/external bearing.
- Small bore.

World-leading resolution.

Large range coupled with a high resolution gives flexibility in measuring large scale profiles while also ensuring small surface details are not lost.

Gauge protection system.

Protect your investment from accidental damage and reduce down time by utilising the built-in rapid collision detection system.

The system stops movement in any direction under automatic or manual mode to prevent collision.



Metrology 4.0

SMART SOFTWARE

In so many ways, it's a first.

Advanced metrology, made simple.

Designed with the operator in mind.

Powerful, intuitive and easy-to-use.

The user interface provides at a glance monitoring of the measurement process.

Real time simulation and true part co-ordinates enable monitoring and control to a level unprecedented in the industry.



Real time display.

The TV view allows the user to track the measurement in real time through the on-screen profile.

This is most beneficial if any dirt, marks or obscurities are seen, as the measurement can be stopped at any point, without any loss of data.

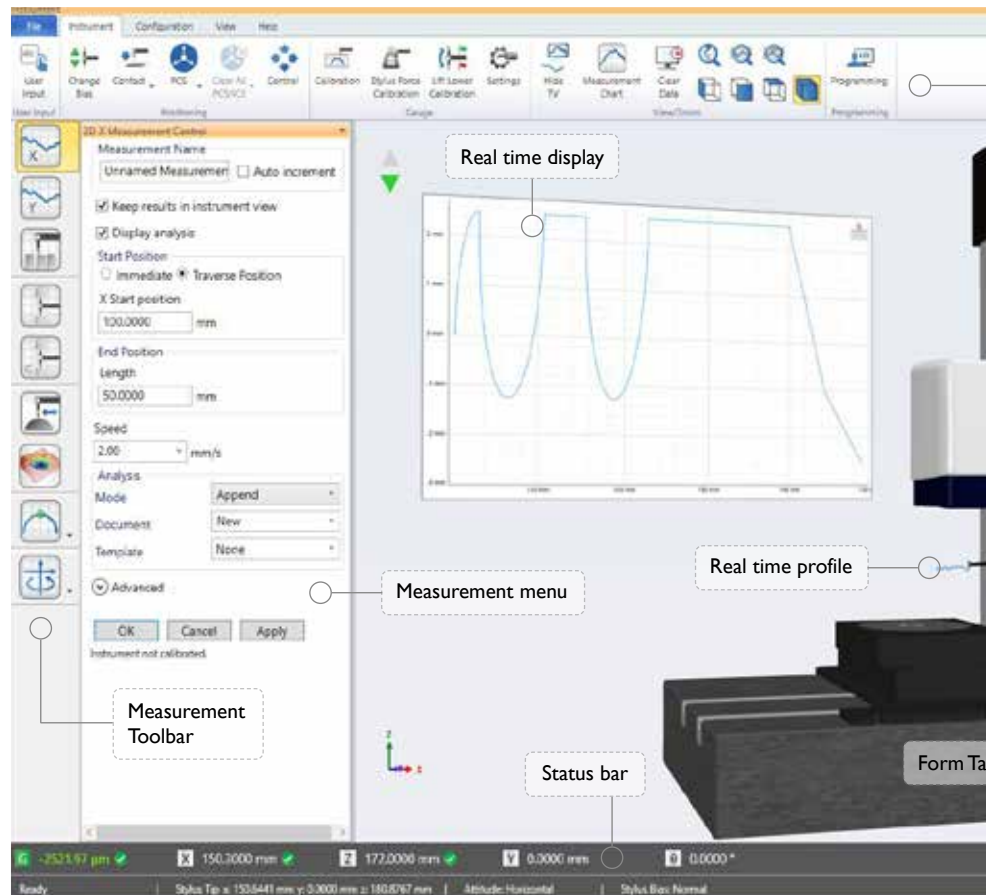

Part Co-ordinate System (PCS).

Metrology 4.0 has two co-ordinate systems; instrument and part.

The part co-ordinate system allows the user to control measurement and movement around any component according to the part drawing.

The on-screen view provides an exact simulation of the real instrument, allowing remote monitoring and at a glance confidence in the measurement process.



Macros.

A new software feature that enables the user to define icon-based functions.

These functions can be set to run custom measurement programs, media messages, instructions, warnings, calibration routines, and much more.

The user has instant and configurable access to all macro functions directly from the instrument control ribbon.



Calibration.

One hit patented calibration routines provide accurate and precise measurements in both single and dual bias mode.

These routines are fast and do not require operator intervention ensuring maximum performance.



Media messages.

Include text, images and videos as operator prompts during programs.

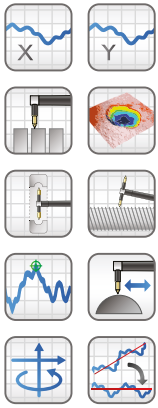

Icon-driven interface.

Metrology 4.0 enables simulation of the measurement process with 'at-a-glance' status, on-screen indicators, real-time feedback and remote system control.

A range of different measurement modes are available via intuitive icons on the measurement tool bar. Tool tips give a detailed overview of the measurement.

Metrology 4.0 advanced measurement types.

- Discontinuous measurement.
- Internal diameter.
- Crest measurement
- Crest analysis - LS Arc, highest point, lowest point and turning point.
- Alignment routines - Cylinder alignment, axial alignment and auto levelling.

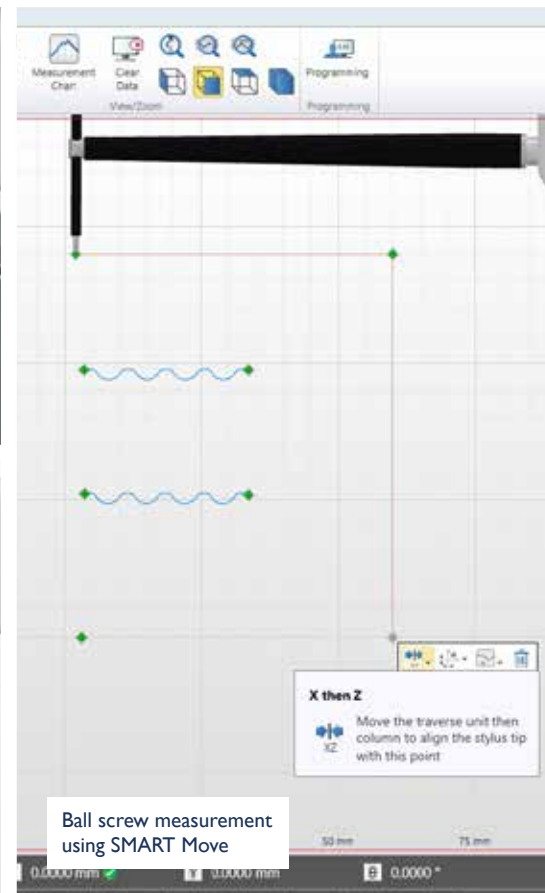
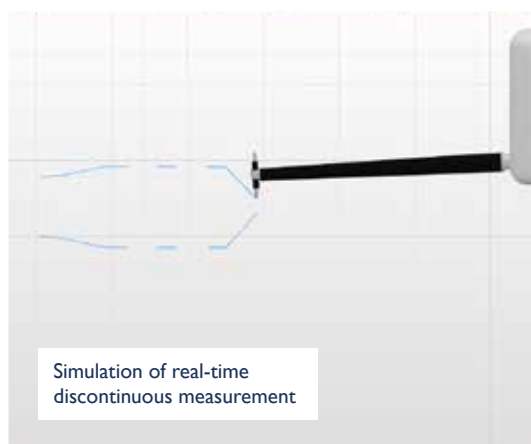

Programming.

A range of different modes that offer basic elements such as recordable part programming and an advanced toolbox of programmable features including variables.

The use of variables reduces the time it takes to create and maintain multiple part programs. This function allows one program to be created for a set of parts of differing sizes.



User Levels.

Tailor your instrument to suit the operator, from basic production mode to advanced administration use.

The password protected modes provide complete control of a user's access, resulting in a tamper-proof software interface for use in the most secure environments.



SMART Move.

A clever tool that allows the user to create points around a part for movement and measurement.

- Simply click on the screen to create a point.
- The instrument will then move the stylus tip to that point.
- The instrument moves using either the traverse, column, Y-stage or a combination of these axes.
- Pre-flight path, allowing the user to predict and control the axes of movement to avoid any obstructions.
- Measurements are made between pre-defined points or from points fed back from the analysis process.
- Improved accuracy and repeatability can be achieved via the unique feedback process.
- A perfect tool for offline programming



Metrology 4.0

SMART SOFTWARE

In so many ways, it's a first.

Advanced metrology, made simple.

Dedicated software analysis packages.

One software platform does all.

Metrology 4.0 includes desktop publishing, automated feedback, roughness, contour, and 3D analysis.

Analysis options:



Surface finish



Contour



Topography

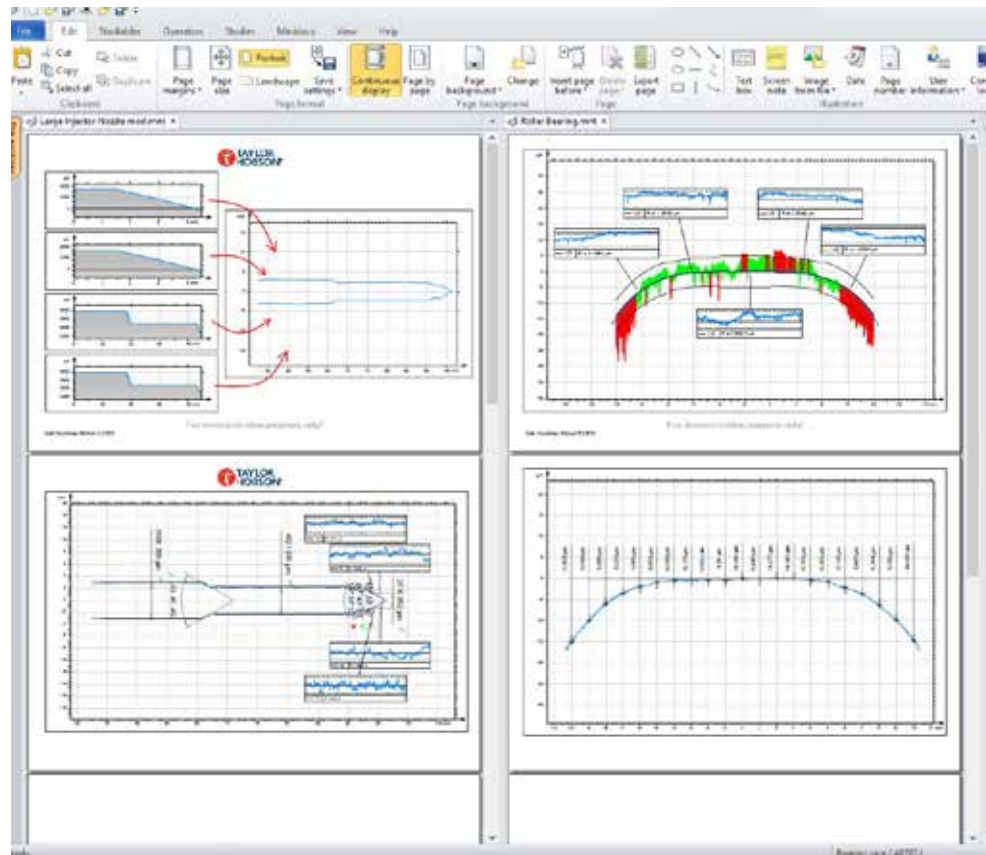

Contour analysis.

An essential tool for geometric dimensioning, tolerancing of profiles and full form deviation analysis.

Save time and increase productivity with automation features within Contour analysis.

Topography analysis.

Transform your 2D measurement in to a powerful 3D analysis to view surface and defects in greater detail using Metrology 4.0 analysis 3D software and a motorised Y-stage.

Critical analysis types.

Surface finish.

- Roughness, waviness and primary.
- Form error and radius.
- Rk parameter set.
- R & W parameter set.
- Dominant wavelength.
- Slope analysis.
- Step height.
- Departure from true form (DFTF).
- Localised slope (LSLP).

Topography.

- 3D mapping.
- Structured surfaces.

Contour.

- Gothic arch.
- Precision diameter.
- Roller profile and drops.
- Angle.
- Wall / Disc thickness.
- Distance measurement.
- Pitch circle diameter (PCD).
- DXF fitting.

Critical analysis functions.

- Morphological filtering.
- Dual Profile.
- Data fusion.
- Helix angle correction.
- Profile patching.



Desktop publishing.

The software allows users to create templates and use them in the analysis process, which vastly simplifies the measurement process.

The desktop publishing features are powerful and simple to use allowing customisation of result layouts and ensuring a more professional and personalised look to your brand.

Benefits.

- Generate interactive reports.
- Compose multi-page documents.
- Multiple documents can be displayed on screen, which enables visual comparison of multiple results at once.
- Build a professional report in a matter of minutes.

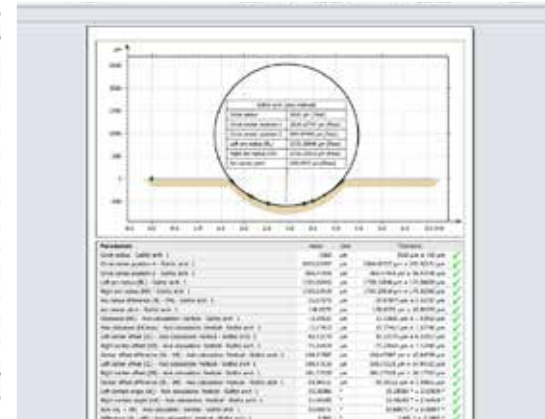
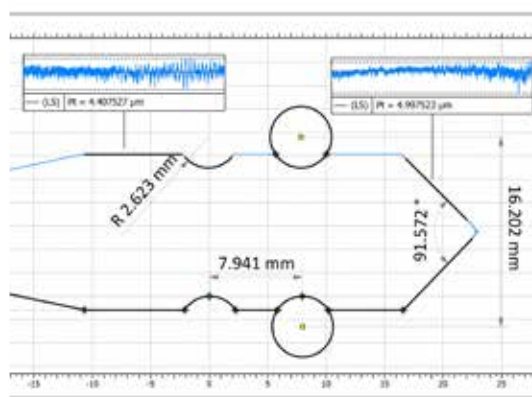
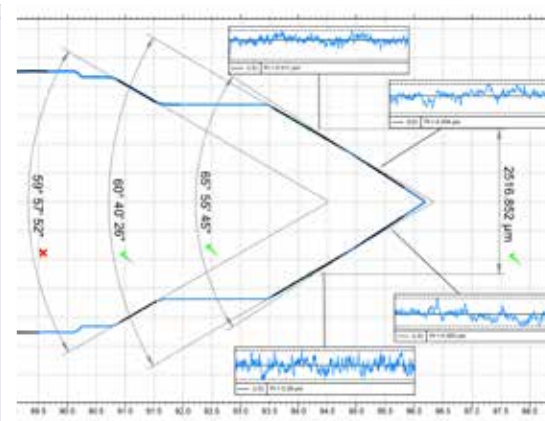
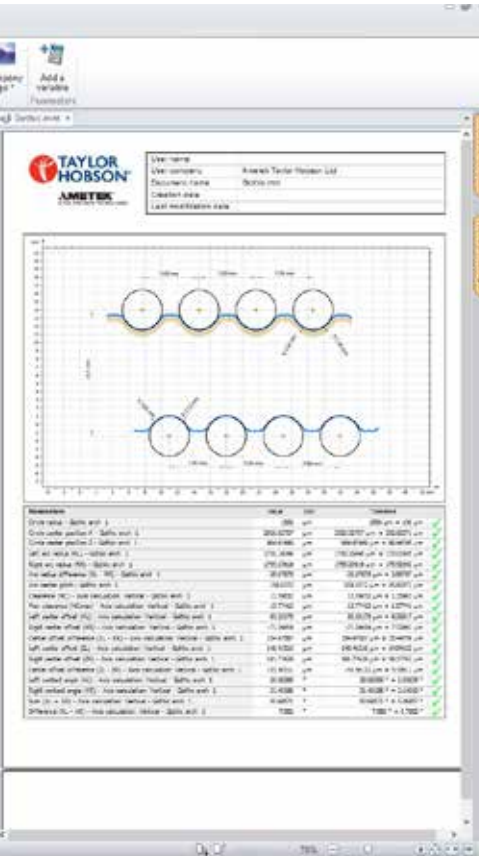

Feedback measurement control.

Repeatability and reproducibility are key to any production process. Metrology 4.0 closes the loop between measurement and analysis by feeding positional information back to the movement or measurement process in order to improve process control.

Movement or measurement can react or be controlled via defined features on a part such as intersections.

Feedback process.

- Measure profile.
- Create datum points for critical features.
- Add datum points to instrument view.
- SMART Move to start position.
- Measure between specified points.
- Apply template to the analysis.



Customised analysis.

Our strategy for success is simple, instead of just selling products, we provide solutions. If our standard software analysis packages do not satisfy your needs, we can customise a solution to match your requirement as an advanced module.

Alternatively Metrology 4.0 has built-in access to execute MATLAB™ files. This enables the user to writing their own scripts and execute them by loading an 'm' file.

Design and program your own...

- Custom filters.
- Custom analyses.
- Custom parameters.

Applications



Ball screw axial measurement - both sides for PCD.

The Form Talysurf® PGI NOVUS provides measurement along the full thread profile on both sides of a ball screw or ball nut. Using helix angle correction the profile is transformed to represent measurements perpendicular to the thread.

Analysis includes: Gothic arch form and parameters, contact point and radius analysis, thread axial surface finish, pitch, pitch circle diameter (PCD) and further analysis of the bearing surfaces, alignment mounts and shaft.



Bearings - spherical, roller and four-point contact.

The Form Talysurf® PGI NOVUS combines form and surface finish measurements with the ability to measure precision diameters, providing a comprehensive assessment for numerous types of bearings.

Spherical bearing analysis includes: LS Arc Auto, surface finish, form deviation, raceway diameter and angle.

Roller bearing analysis includes: DXF fitting, roller profile and drops, residual results, tolerancing and surface finish.

Four-point contact bearing analysis includes: Gothic arch, surface finish, dimensions, contact angle, radius, X and Z offset.

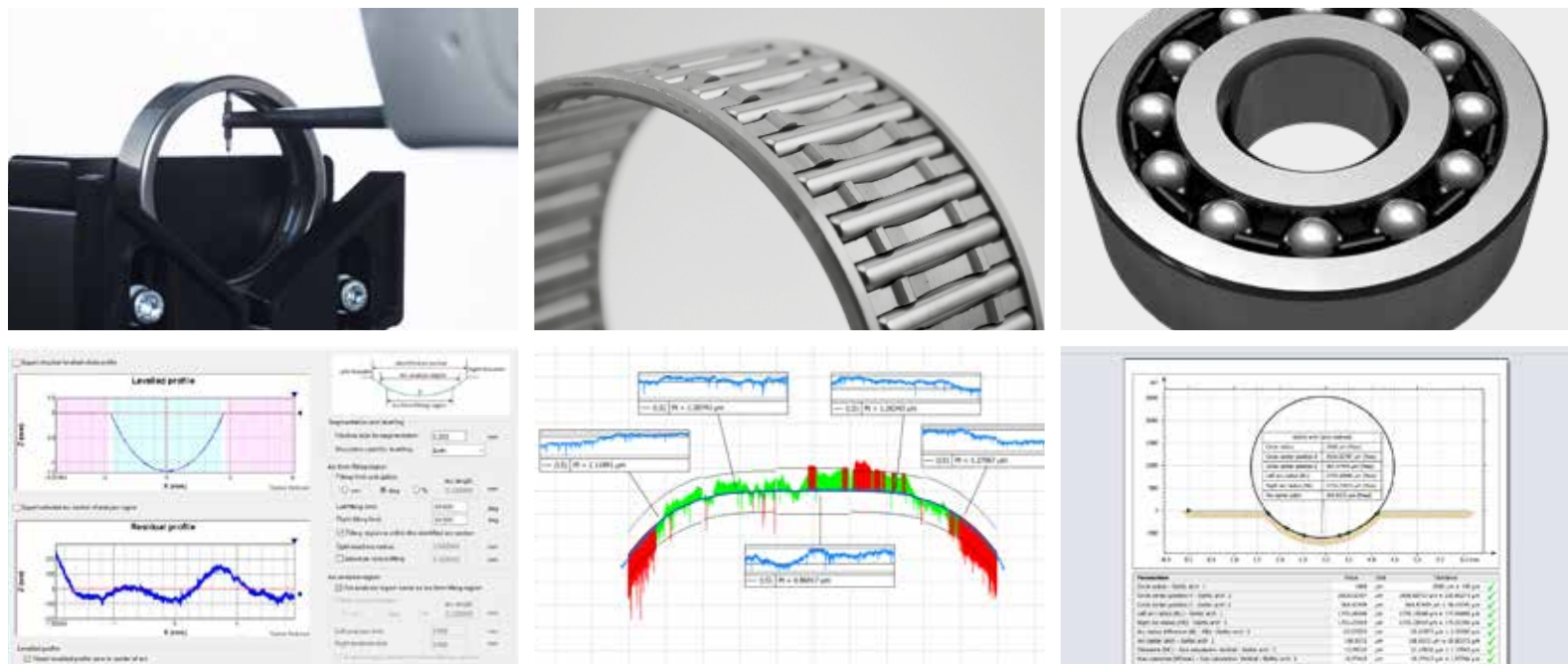



Gears - involute form.

Gear surface finish can be assessed and separate involute profiles combined for subsequent analysis.

Analysis includes: Surface finish, morphological filter, profile patching, involute form removal and tooth angle.

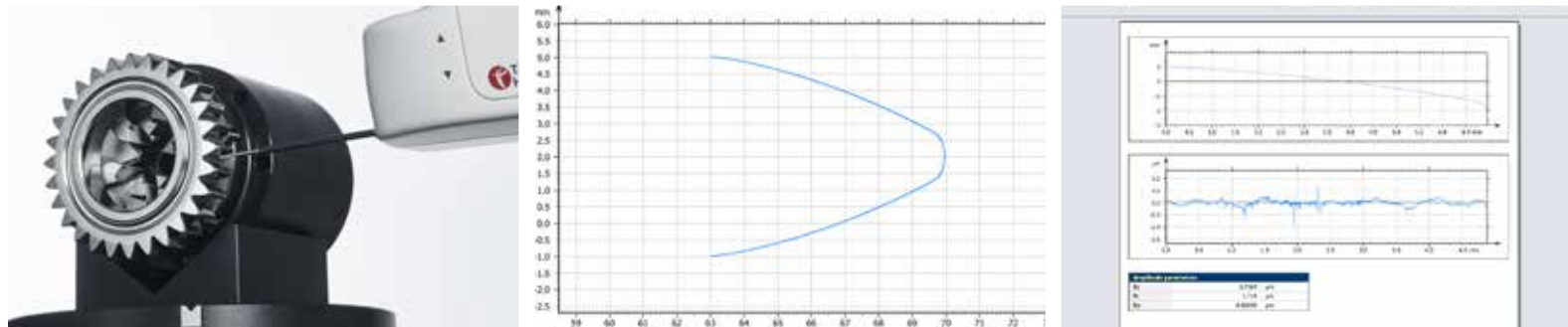

Fuel injectors - straightness and seat angle.

The dual bias gauge on the Form Talysurf® PGI NOVUS provides unmatched precision for injector pin, diameter and cone angle measurement. Time can be saved by measuring seat straightness and surface finish using a single stylus and morphological filter.

Analysis includes: Auto patch of profiles, diameter and dimensions, true cone angle, surface finish, seat straightness.

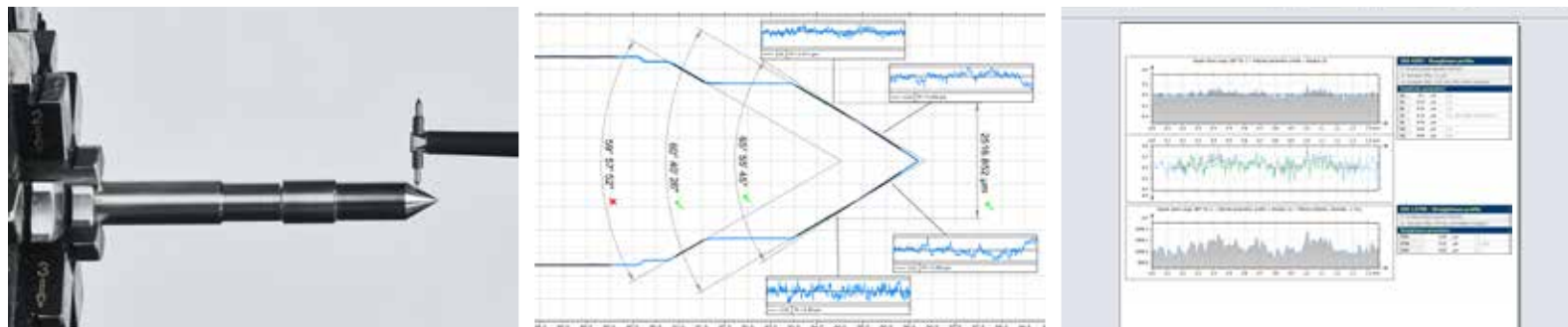

Multi-part measurement - using a single program.

A single program can be used to auto-detect and measure multiple parts of similar or different sizes. The measurement process is fully automated and can be started by user part selection, auto-part detection or by using a barcode reader.

Capabilities include: Pallet interface, barcode reader, part variables, operator-less attendance and media messaging.



Traceability



0026

2624

Full traceability to international standards. Critical results, trust Taylor Hobson.



Traceability.

Taylor Hobson provides full certification for artefacts and instruments in our purpose built ISO graded clean room UKAS facility.

Our UKAS laboratory is able to measure all of the parameters associated with surface texture, including French, German, USA and Japanese derivatives.

Arcuate correction.

The Form Talysurf® systems use a patented ball calibration routine to ensure that both dimensional measurement capability and gauge linearity are dealt with in a single, automated operation.

This fast and simple process uses high-precision spherical calibration artefacts that have been produced to exacting standards and then calibrated for radius and form traceable to international standards.

Datum straightness.

To ensure the traverse unit conforms to specifications Taylor Hobson can supply Zerodur straightness standards.

These standards provide certainty in the traverse direction and are combined with special software routines to enhance the measuring axis for correct geometrical form.

Surface finish.

Taylor Hobson can provide glass or metal roughness standards calibrated to an uncertainty of $\pm(2\% + 4 \text{ nm})$ providing measurement confidence and compliance for peak parameters with respect to ISO standards.

Spacing standards are also available to an uncertainty of $\pm 0.6 \mu\text{m}$.

Step height.

To ensure the correct gain setting of your instrument, high precision step height standards are available; calibrated with uncertainties down to $\pm 4 \text{ nm}$.

Grating correction.

All our traverse units are tested and enhanced using interferometric techniques ensuring accurate dimensional and surface texture measurement in the x direction.

For further information please visit our website or contact our worldwide Centre of Excellence.

T: +44 (0)116 276 3779
E: taylor-hobson.cofe@ametek.com
W: www.taylor-hobson.com

Designed to meet your individual requirements.
Performance in all environments.

Configurations.

The unique options support high accuracy measurements in all environments from shop floor to laboratory.

1. Form Talysurf® PGI NOVUS, environmental chamber, surround with shelf and display monitors at the front.
2. Form Talysurf® PGI NOVUS, surround with shelf and display monitors at the back.
3. Form Talysurf® PGI NOVUS, surround and display monitor on a separate desk.

Further versions

- Active AV mounts, environmental chamber, surround with shelf and display monitors at the front.
- Standard steel frame with display monitors on separate desk.



The Metrology Experts

Established in 1886, Taylor Hobson is the world leader in surface and form metrology and developed the first roundness and surface finish measuring instruments.

www.taylor-hobson.com

Sales department

Email: taylor-hobson.sales@ametek.com

Tel: +44 (0) 116 276 3771

- **Design engineering** – special purpose, dedicated metrology systems for demanding applications.
- **Precision manufacturing** – contract machining services for high precision applications and industries.

Centre of Excellence department

Email: taylor-hobson.cofe@ametek.com

Tel: +44 (0) 116 276 3779

- **Inspection services** – measurement of your production parts by skilled technicians using industry leading instruments in accord with ISO standards.
- **Metrology training** – practical, hands-on training courses for roundness and surface finish conducted by experienced metrologists.
- **Operator training** – on-site instruction will lead to greater proficiency and higher productivity.
- **UKAS calibration and testing** – certification for artifacts or instruments in our laboratory or at customer's site.

Service department

Email: taylor-hobson.service@ametek.com

Tel: +44 (0) 116 246 2900

- **Preventative maintenance** – protect your metrology investment with an AMECare support agreement.



© Taylor Hobson Ltd. 2018



Taylor Hobson UK

(Global Headquarters)

PO Box 36, 2 New Star Road
Leicester, LE4 9JQ, England

Tel: +44 (0)116 276 3771

taylor-hobson.sales@ametek.com



Taylor Hobson France

Rond Point de l'Epine Champs
Batiment D, 78990 Elancourt, France

Tel: +33 130 68 89 30

taylor-hobson.france@ametek.com



Taylor Hobson Germany

Rudolf-Diesel-Straße 16,
D-64331 Weiterstadt, Germany

Tel: +49 6150 543 0

taylor-hobson.germany@ametek.com



Taylor Hobson Italy

Via De Barzi, 20087 Robecco sul Naviglio,
Milan, Italy

Tel: +39 02 946 93401

taylor-hobson.italy@ametek.com



Taylor Hobson India

Divyasree NR Enclave, 4th Floor, Block A,
Plot No. 1, EPIP Industrial Area, Whitefield,
Bengaluru - 560066, India

Tel: +91 80 6782 3346

taylor-hobson.india@ametek.com



Taylor Hobson China

taylor-hobson-china.sales@ametek.com

Shanghai Office

Part A1, A4, 2nd Floor, Building No. 1, No. 526
Fute 3rd Road East, Pilot Free Trade Zone,
Shanghai, 200131, China

Tel: +86 21 5868 5111-110

Beijing Office

Western Section, 2nd Floor, Jing Dong Fang
Building (B10), No. 10, Jiu Xian Qiao Road,
Chaoyang District, Beijing, 100015, China

Tel: +86 10 8526 2111

Chengdu Office

Unit 9-10, 10th Floor 9/F, Hi-tech Incubation
Park, No.26 West Jinyue Road, Chengdu,
610041, China

Tel: +86 28 8675 8111

Guangzhou Office

Room 810 Dongbao Plaza, No.767 East
Dongfeng Road, Guangzhou, 510600, China

Tel: +86 20 8363 4768



Taylor Hobson Japan

3F Shiba NBF Tower, 1-1-30, Shiba Daimon
Minato-ku, Tokyo 105-0012, Japan

Tel: +81 34400 2400

taylor-hobson.japan@ametek.com



Taylor Hobson Korea

#309, 3rd FL, Gyeonggi R&DB Center, 105,
Gwanggyo-ro, Yeongtong-gu, Suwon-si,
Gyeonggi-do, Korea, 16229

Tel: +82 31 888 5255

taylor-hobson.korea@ametek.com



Taylor Hobson Singapore

AMETEK singapore, 10 Ang Mo Kio Street 65,
No. 05-12 Techpoint, Singapore 569059

Tel: +65 6484 2388 Ext 120

taylor-hobson.singapore@ametek.com



Taylor Hobson Thailand

89/45, Moo 15, Enterprise Park, Bangna-Trad
Road, Tambol Bangkaew, Amphur Bangplee,
Samutprakarn Province 10540, Thailand

Tel: +66 2 0127500 Ext 505

taylor-hobson.thailand@ametek.com



Taylor Hobson Taiwan

10F-5, No.120, Sec. 2, Gongdao Wu Rd.,
Hsinchu City 30072, Taiwan

Tel: +886 3 575 0099 Ext 301

taylor-hobson.taiwan@ametek.com



Taylor Hobson Mexico

Acceso III No. 16 Nave 3 Parque Ind. Benito
Juarez Queretaro, Qro. Mexico C.P. 76120

Tel: +52 442 426 4480

taylor-hobson.mexico@ametek.com



Taylor Hobson USA

27755 Diehl Road, Suite 300, Warrenville,
IL 60555, USA

Tel: +1 630 621 3099

taylor-hobson.usa@ametek.com



1100 Cassatt Road, Berwyn, PA 19312, USA

Email: info.corp@ametek.com

Web: www.ametek.com