

# Form Talysurf<sup>®</sup> CNC Series



Versatile, high range, high resolution system for automated surface finish and contour inspection

# Form Talysurf<sup>®</sup> CNC Series

## Driving quality control in manufacturing. **Automated surface finish, form and contour.**

While the use of highly automated manufacturing systems in automotive production is well established, quality control has remained a manual process. The arrival of the Form Talysurf<sup>®</sup> CNC Series for automated quality control will change that.

The system can be programmed to your individual requirements for analysis of crankshafts, heads, blocks, gear box casings and much more.

The Form Talysurf<sup>®</sup> CNC Series is supplied with Taylor Hobson's Q-Link production interface, software that meets the Industry 4.0 philosophy.

Q-Link is designed for shop floor environments and provides direct communication with SPC software which delivers feedback to your manufacturing process.

Component handling and loading is made easy with dedicated fixtures. Operator mistakes can be prevented with programmed measurement routines and the simultaneous fast axis movements to reduce cycle times and increase throughput.

### An excellent investment.

-  Transmission housings
-  Cylinder heads and blocks
-  Crankshafts and camshafts
-  Valves and pistons
-  Gears, conrods and injectors
-  Hydraulic components

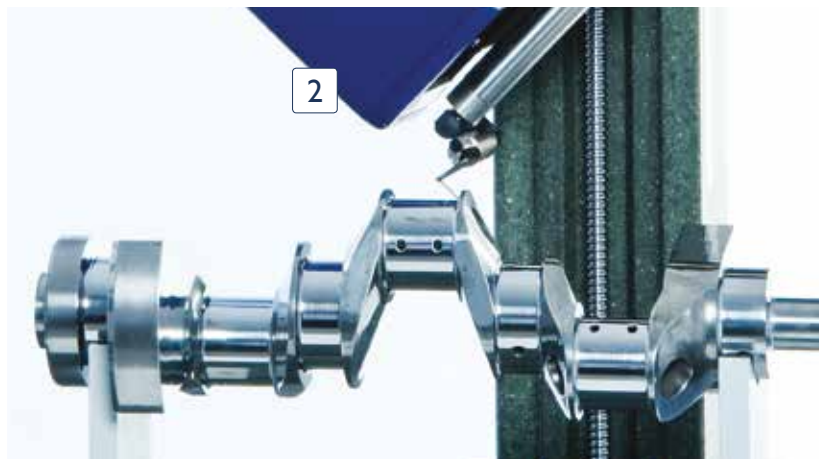

### Measurement integrity and reproducibility.

#### 1 High accuracy gauge.

World-leading 5 mm gauge with 0,4 nm resolution and unique temperature compensation as standard.

#### 2 Traverse tilt.

Motorised  $\pm 9^\circ$  tilt or manual  $9^\circ$ - $45^\circ$  tilt traverse unit, enables the measurements of fillet radii on crankshafts and valve seats on cylinder heads.

#### 3 Precision column.

Available in 700 mm or 1000 mm height. Programmed to automatically move on the motorised Y-axis stage.

## Gauge

5

High gauge range  
5 mm

## Roughness



Low noise floor  
Less than 20 nm Rq

## Contour



Pt  
Less than 0.25 µm

## Weight



Large payload capacity  
Up to 150 kg

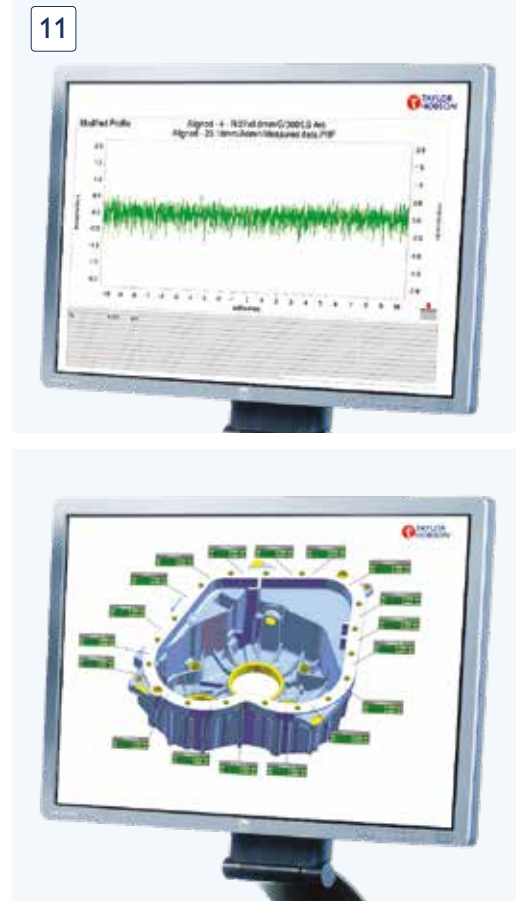

### 4 Traverse unit.

Available in 120 mm or 200 mm length, the traverse unit enables measurement over large multi-featured parts.

### 5 Fixtures.

Dedicated stable fixtures designed for fast fitting and set-up of components.

### 6 Full component access.

Precise control via rotary and 300 mm X-stage for fast, simultaneous and accurate component positioning.

### 7 Granite base.

The base is made out of high-grade granite to provide high vibration damping, thermal inertia and stiffness throughout the measurement cycle.

### 8 Anti-Vibration system.

Self levelling, passive air mounts work in conjunction with the steel support frame to reduce measurement noise in shop floor environments.

### 9 Support steel frame.

Strong rigid steel support frame; includes heavy duty levelling mechanism for all four legs.

### 10 ECU cabinet.

Industrial electrical PC cabinet designed to control temperatures and optimise cooling.

### 11 Ultra software.

Powerful analysis software for all parameters. Unique user interface tailored to the needs of the operation.

# SMART manufacturing







## The future of modern manufacturing. **Forward thinking.**

Taylor Hobson has developed the Q-Link interface to support automation, data exchange and process control in manufacturing environments.

The Q-DAS accredited production interface is designed for shop floor environments and provides direct communication with SPC software, which delivers feedback to your manufacturing process.

This form of monitoring is used widely in automotive and aerospace component manufacturing, where data and strict standard operating procedure control is mandatory.

### User benefits.

-  Programs reduce operator mistakes.
-  Programmed measurement routines reduce cycle times and increase throughput.
-  Display traceable pass/fail results and automatic summary reports.
-  Historic traceability is made possible via data exchange and part tracking.
-  Control can be managed by barcode scanners or tracking/auditing system.
-  Statistics such as automatic R&R studies.
-  Tolerancing - Visually identifies the parameter and tolerance band.



## Taylor Hobson metrology directly monitoring production.

The Form Talysurf® CNC Series not only continues a tradition of taking measurement accuracy to the next level, but reflects the evolution of the manufacturing industry.

*"Meeting manufacturing challenges is at the heart of our business"*

Dr. Bob Bennett, Technical Director.  
– Taylor Hobson Ltd.

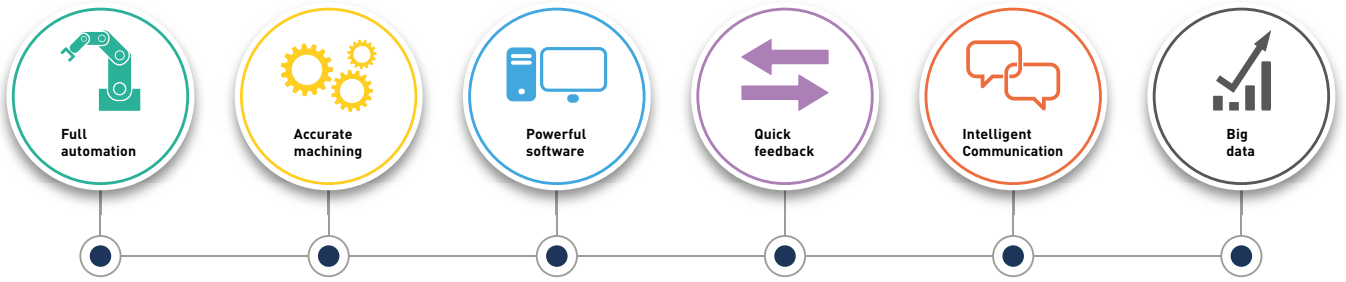

**Typical applications**  
 Crankshafts, heads, blocks, gear box casings, camshafts, gears, conrods, injectors, valves, pistons, ball screws and hydraulic components.

## Industry 4.0 in action.

All of the critical components for the Form Talysurf® systems are manufactured in-house at our UK facility, with unique serial numbers for worldwide traceability.

Taylor Hobson has invested in the latest machining techniques to deliver measurement integrity through manufacturing excellence.



*"Our strong investment meets the demands of high technology manufacturing"*

**Tim Garner, Operations Director.**  
**– Taylor Hobson Ltd.**

Taylor Hobson's latest investment includes the Mazak Integrex i-200S with 10 axis, twin spindle, in cycle probing, tool break detection, unmanned running, temperature control, zero set up times, auto re-loading, high accuracy glass scales and 110 tool capacity.

# Unparalleled measurement capability

## Form Talysurf® CNC Series.

### Designed with the operator in mind.

#### System benefits and features.

- **Cycle times are greatly reduced**  
Up to 8 axes of motion
- **High accuracy gauge**  
World-leading 5 mm gauge with 0.4 nm resolution
- **Temperature compensation**  
Ensures consistent system performance and high measurement integrity, regardless of environmental effects
- **Fully automated measurement**  
With evaluation and SPC analysis
- **Simple user friendly interface**  
Ideal for programming and analysis
- **Customisable fixtures and workholdings**  
Part identification using RFID and barcodes
- **1.5 metre granite base for workpieces**  
Up to 400 mm in size and weight up to 150 kg\*
- **Robust measurement solution**  
Suitable for all environments

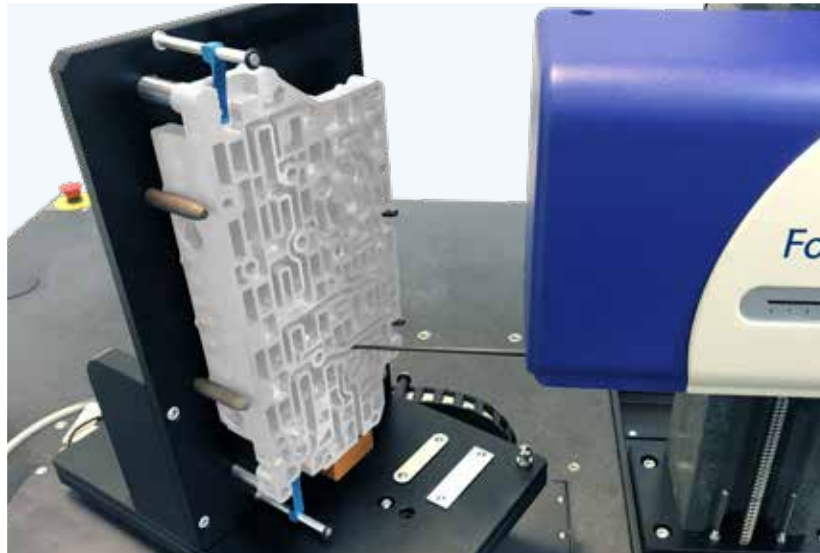

#### System options.

##### Form Talysurf® CNC 2000 Series

**CNC 2150 & 2075** - Suitable for large engine heads and blocks.

- 700 mm column with  $\pm 9^\circ$  motorised tilt.
- 200 mm traverse unit.
- Automated gauge stem rotation.
- CNC 2150 - weight capacity up to 150 kg\*, ideally suited to 6 cylinder blocks and heads.
- CNC 2075 - weight capacity up to 75 kg\*, ideally suited to 4 cylinder blocks and heads.

##### Form Talysurf® CNC 1000 Series

**CNC 1150 & 1075** - Suitable for large crankshafts or transmission housings.

- 700 mm column with  $+9-45^\circ$  manual tilt.
- 120 mm traverse unit.
- Manual gauge stem rotation.
- CNC 1150 - weight capacity up to 150 kg\*, ideally suited to 6 cylinder crankshafts and camshafts.
- CNC 1075 - weight capacity up to 75 kg\*, ideally suited to 4 cylinder crankshafts and camshafts.

# Powerful analysis software.

## Dedicated packages available.

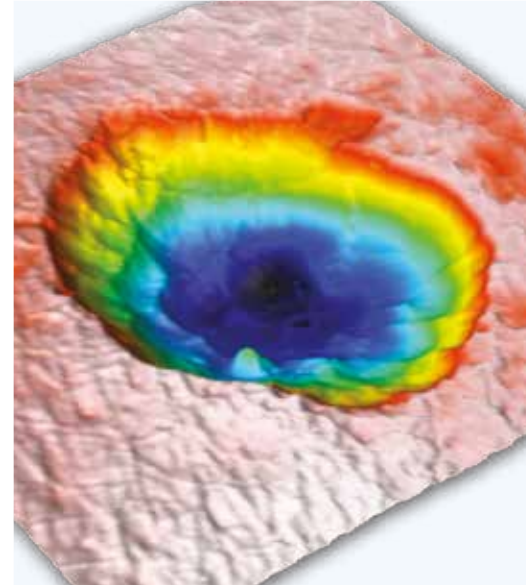
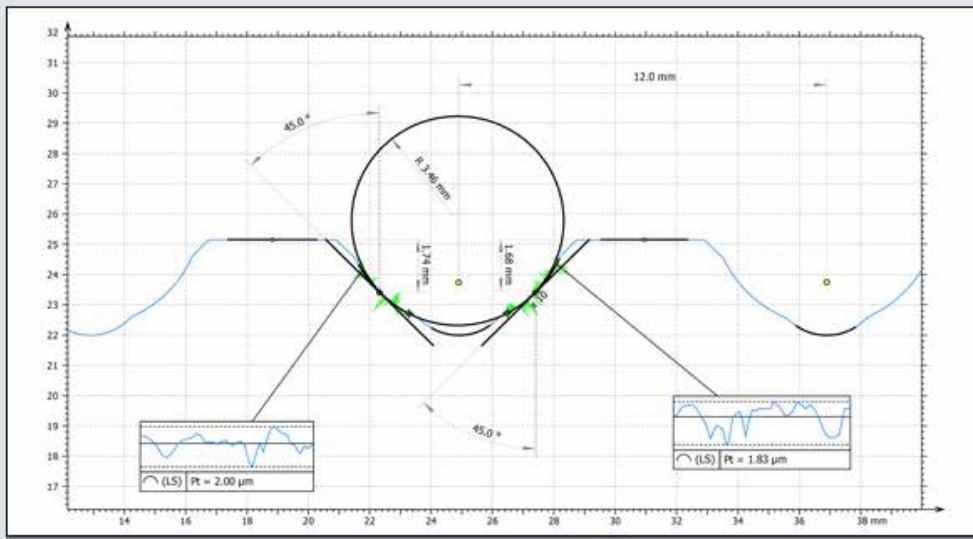
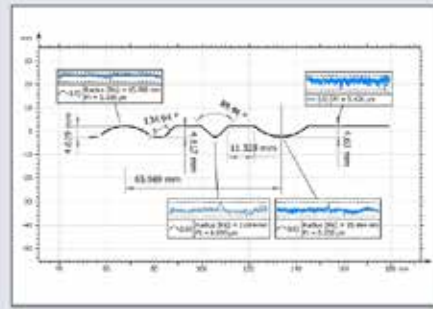
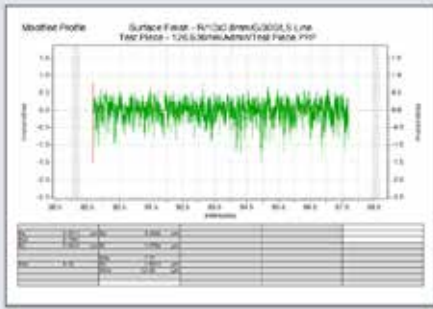

## Analysis capabilities.

### Save time and money - one measurement, multiple results.

Ultra Software - Powerful analysis software for all parameters. Choose Taylor Hobson's optional production interface to automate control and reporting. Customisation through Taylor Hobson's unique user interface tailored to the needs of the operator, with customisable menus, displays and user levels.

#### Surface analysis

- Form
- Radius
- Roughness
- Waviness
- Dominant wavelength

#### Contour analysis

- Radius
- Angle
- Height
- Length
- Distance and more

#### 3D analysis

Use our optional TalyMap® 3D software to transform your conventional 2D measurements in to 3D analysis results.

# Expanding your capability

Full automation with a wide variety of fixtures and different axis configurations.

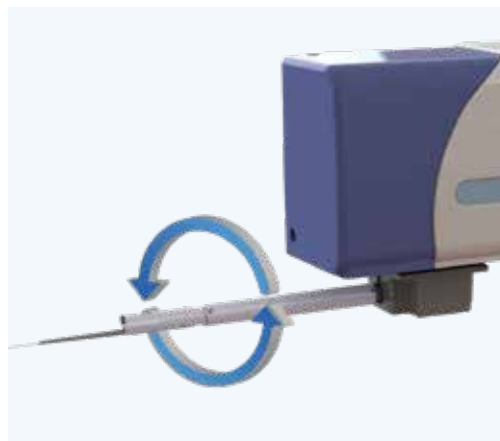

## Optional accessories.

### Automated rotation system.

Fully automated 360° axial gauge rotation for surface finish and form measurements of internal bores and between faces.

### Customisable user interface.

Unique user interface tailored to the needs of the operator, with customisable menus, displays and user levels.

### Wide range gauge.

Increase your system flexibility by changing to the wide range gauge to increase your gauge range to 28 mm and to fulfil your contour requirements.

### Right angle attachment.

90° gauge attachment to allow access to features inaccessible by inline measurement.

### Automated part identification.

Fully automated part identification and program operation via RFID or barcode.

Simply place the component onto the system and read the tag or barcode and the software automatically selects the correct program and initiates the measurement routine, removing any operator involvement or error.



# Designed to suit your application

Meeting the ever increasing demands of next-generation technologies.

## Cylinder blocks and heads.

- Form, surface finish and angle of valve seats and guides
- Deck face surface finish and form
- Surface finish and form - Cylinder, balancer, crankshaft and camshaft bores
- Geometry of threaded holes

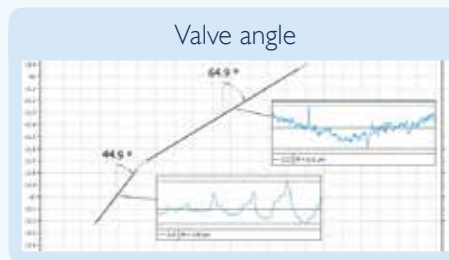

## Crankshafts and camshafts.

- Geometry and surface finish of fillet radii between thrust faces and pin bearings
- Form, geometry and surface finish of the pin and main bearings
- Tooth surface finish and geometry
- Cam heal and toe geometry

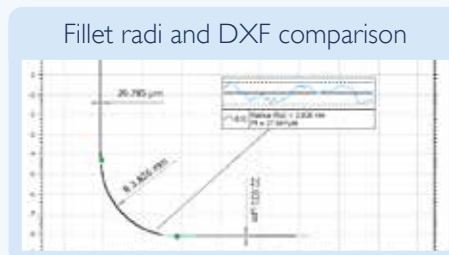

## Transmission housings.

- Surface finish and waviness of sealing faces and inlet bores
- Automated surface flatness of sealing faces

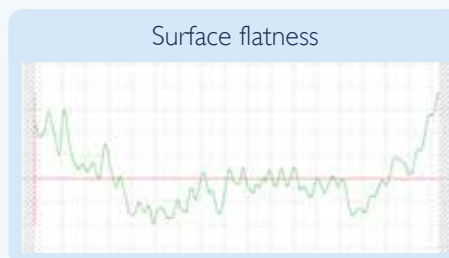

## Gears.

- Deviation of root radius from design
- Surface finish and individual tooth profile
- Form measurement of splines

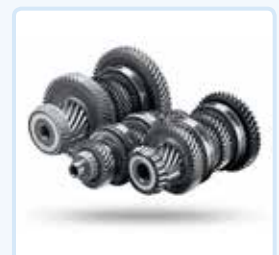
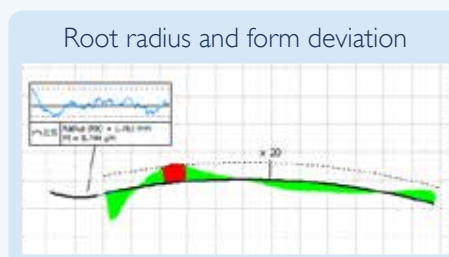



# Full suite of dedicated software packages

Taylor Hobson has a long history with advanced manufacturing, this association has helped to evolve powerful software solutions to suit your applications.

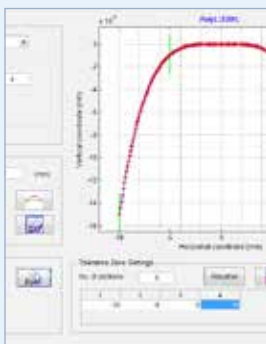

## DXF Creator

A utility that allows creation of DXF data, enabling comparison of design profile to part profile.

- Logarithmic equation
- Free form equations
- Tolerance zones

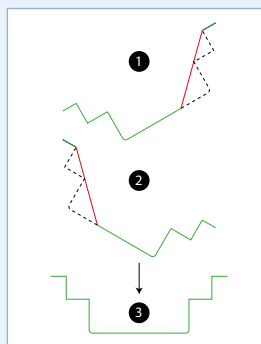

## Data fusion

Where components profiles are demanding in angle and form, complete analysis can be made by fitting several measured profiles together into one profile using the patented data fusion process.

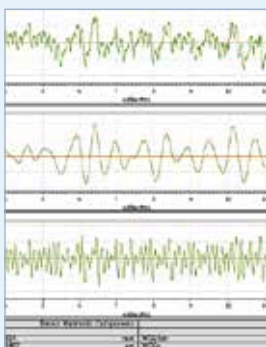

## Dominant Wavelength

This analysis function isolates the two most dominant wavelengths contained within a surface. This allows manufacturers to track and isolate errors, control process and predict function.

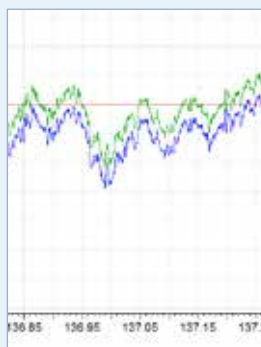

## Advanced Dual Profile

A sophisticated comparison tool that allows testing of:

- Wear
- Repeatability
- Noise



## Remote access

Using the 'remote access' feature in the Ultra software, a third party application has the ability to run the Ultra program, for example, using a robotic arm to place the part on a fixture.

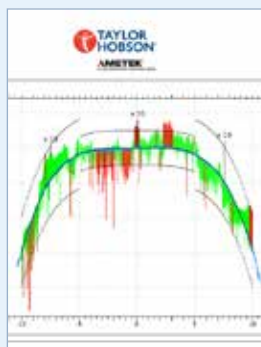

## TalyMap<sup>®</sup> Contour

Allows alignment of measured profiles to design data as well as automated dimensioning.

- Tolerance zones
- Error deviation
- x-offset calculation

# Key features in TalyMap<sup>®</sup> Contour.

## Analysis of length, radius, angle and more...

### Desktop publishing

Quick & instant report generation.



### Comparison with CAD models

Load DXF models and automatically fit to the measured profile, results will display deviations, tolerance limits and deviation parameters.

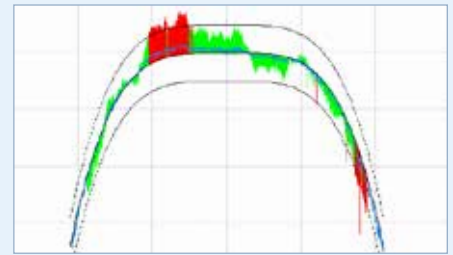

### Ease of use

Contour software is easy to use and requires minimal training. Intuitive icon based tools allow the user to define and modify elements and dimensions with the click of a button.

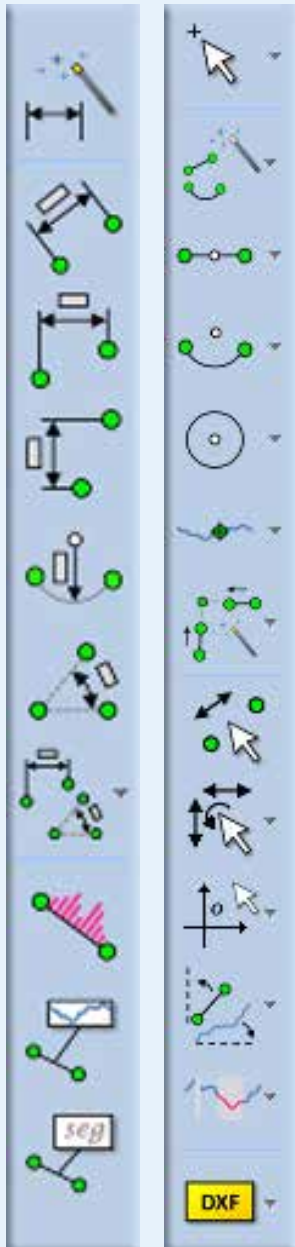

### Automation

Reports and analysis routines can be saved as single templates and re-applied to component batches.

Special software routines allow full automation regardless of part variation or positional set up ensuring repeatable results.

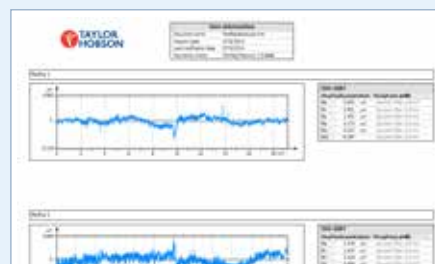
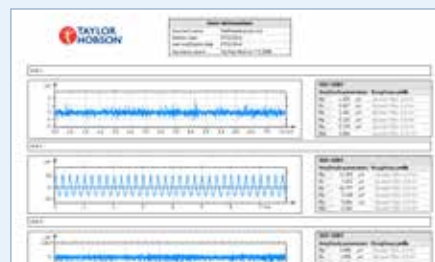
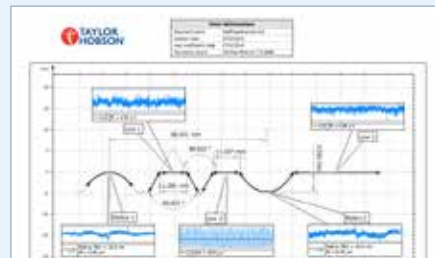

### Full dimensional analysis

Linear, Angular, Radial and more.

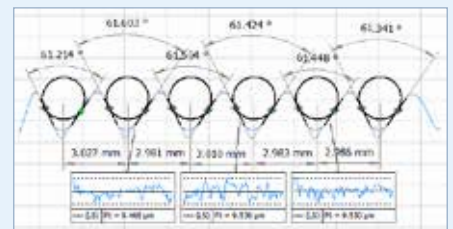
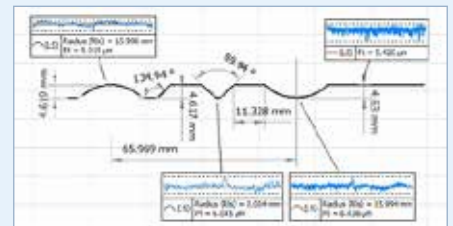

### Further analyses

Gothic arch profile analysis as standard.

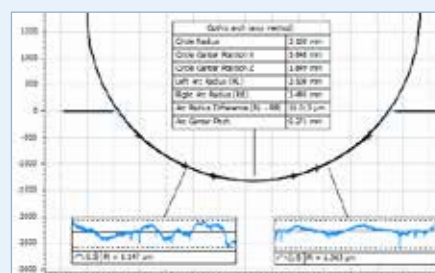

### Q-Link Compatible

Take advantage of automatic reporting and exporting in Q-Das or text format.

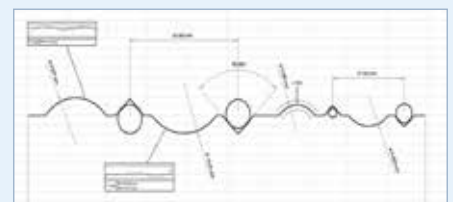
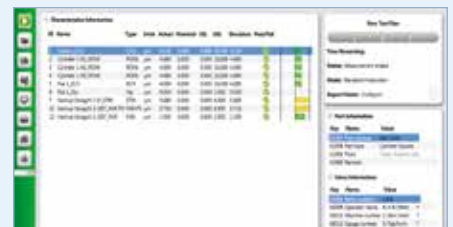

# Traceability



0026

2624

## Full traceability to international standards. Critical results, trust Taylor Hobson.



Taylor Hobson is the only company that can prove measurement capability over the full gauge range.

### Traceability.

Taylor Hobson provides full certification for artefacts and instruments in our purpose built ISO graded clean room UKAS facility.

Our UKAS laboratory is able to measure all of the parameters associated with surface texture, including French, German, USA and Japanese derivatives.

### Arcuate correction.

The Form Talysurf® systems use a patented ball calibration routine to ensure that both dimensional measurement capability and gauge linearity are dealt with in a single, automated operation.

This fast and simple process uses high-precision spherical calibration artefacts that have been produced to exacting standards and then calibrated for radius and form traceable to international standards.

### Datum straightness.

To ensure the traverse unit conforms to specifications Taylor Hobson can supply Zerodur straightness standards.

These standards provide certainty in the traverse direction and are combined with special software routines to enhance the measuring axis for correct geometrical form.

### Surface finish.

Taylor Hobson can provide glass or metal roughness standards calibrated to an uncertainty of  $\pm(2\% + 4 \text{ nm})$  providing measurement confidence and compliance for peak parameters with respect to ISO standards.

Spacing standards are also available to an uncertainty of  $\pm 0.6 \mu\text{m}$ .

### Step height.

To ensure the correct gain setting of your instrument, high precision step height standards are available; calibrated with uncertainties down to  $\pm 4 \text{ nm}$ .

### Grating correction.

All our traverse units are tested and enhanced using interferometric techniques ensuring accurate dimensional and surface texture measurement in the x direction.

For further information please visit our website or contact our worldwide Centre of Excellence.

**T:** +44 (0)116 276 3779  
**E:** taylor-hobson.cofe@ametek.com  
**W:** www.taylor-hobson.com

# Ultra software.

## Surface finish parameters.

### Form removal and analysis functions

#### Form error

Deviation from nominal form is calculated with reference to a best fit straight line, best fit circular arc or best fit conic section.

Form deviation may also be calculated with reference to a minimum zone straight line (the minimum separation between two parallel lines containing the data set).

#### Radius

Using a least squares best fit, the radius of concave or convex circular arcs can be automatically calculated from selected data. An option to exclude any unwanted features such as edges is also available.

Alternatively, the absolute radius can be set to analyse the actual deviation from a design master. Other calculated parameters include the centre coordinate.

#### Angle (slope)

Surface tilt can be determined and removed prior to parameter analysis by means of a straight line or minimum zone algorithm. Other calculated values include intercept and pitch.

#### Dimension

The linear relationship of surface features can be assessed and compared by means of calculated X & Z coordinate positions.

- Datum slope
- Delta slope
- Pitch (between centres)
- Intercept X / Intercept Z

#### Dual profile

This analysis function enables comparison of one measured profile to another or even to a master profile which has been saved as a template. A 'difference' profile can be displayed at the touch of a button and used for further analyses.

### Surface finish parameters

#### Primary parameters

DFTF, LSLP Ave, LSLP Max, Pa, Pc, PCf, PCI, PCr, Pda\*, Pdc\*, Pdq\*, PHSC\*, Pku, Pln, PLo, Plq, Pmr\*, Pmr(C)\*, Pp, PPc\*, Pq, PS, Psk, PSm, Pt, Pv, PVo\*, Pz, Pz(JIS).

#### Roughness parameters

R3y, Ra, Rc, RCf, RCI, RCr, Rda\*, Rdc\*, Rdq\*, RHSC\*, Rku, Rln, RLo, Rlq, Rmr\*, Rmr(C)\*, Rp, Rp1max, Rpc\*, Rq, RS, Rsk, RSm, Rt, Rv, Rv1max, RVo\*, Rz, Rz(DIN), Rz(JIS), Rz(n)\*, Rz1max.

#### Waviness parameters

Wa, Wc, Wcf, WCI, WCr, Wda\*, Wdc\*, Wdq\*, WHSC\*, Wku, Wln, WLo, Wlq, Wmr\*, Wmr(C)\*, Wp, Wpc\*, Wq, WS, Wsk, WSm, Wsa, Wst, Wt, Wv, WVo\*, Wz.

#### Rk parameters and Rk curve

A1, A2, APH, AVH, CV, Mr1, Mr2, Rk, Rpk, Rvk, Rvk/Rk.

#### R & W parameters

AR, AW, Pt, R, Rke, Rn, Rpke, Rvke, Rx, Sar, Saw, Sr, Sw, W, Wn, Wte, Wx.

#### Dominant wavelength

WD1c, WD1Sm, WD1t, WD2c, WD2Sm, WD2t, WDSmMax, WDSmMin.

### Filters and additional features

#### Filters

Gaussian, Robust Gaussian, Gaussian VDA, Morphological, ISO 2CR, 2CR PC, Rk, Spline.

#### Cut-off (Lc)

0.08, 0.25, 0.8, 2.5, 8, 25 mm and operator input.

#### Bandwidth

10:1, 30:1, 100:1, 300:1 and 1000:1 or as defined by data spacing (VDA2006).

#### Note

Where applicable the parameters conform to and are named as per the standards:

- ISO4287:1997
- ISO13565-2:1996
- ISO12085:1996

\* All parameters marked with an asterisk require user assigned single or multiple qualifiers. For example, material ratio may be assessed at one or more slice levels within a single measurement.

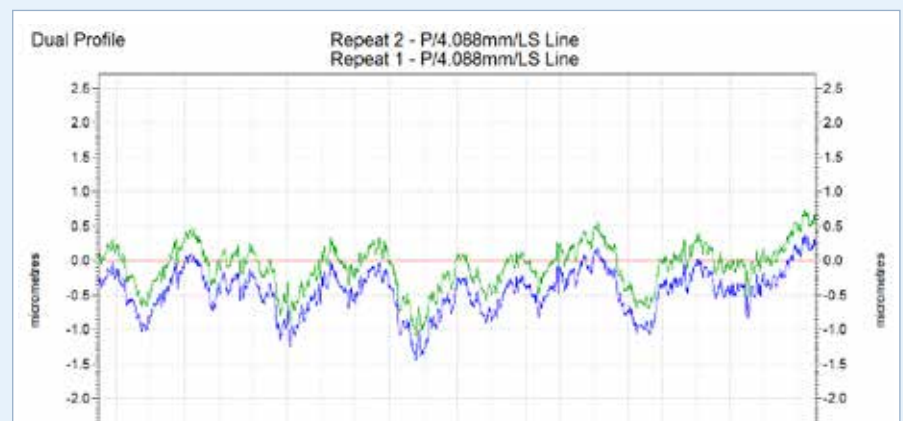

Dual Profile analysis allows two sets of measurement data to be displayed at once and is ideal for testing system noise and repeatability

# Specification

## Horizontal performance

Traverse length – X max / min	120 mm / 0.1 mm (4.7 in / 0.004 in)	200 mm / 0.1 mm (7.9 in / 0.004 in)
Traverse speeds	13 mm/s (0.51 in/s) max	
Measuring speed <sup>5</sup>	0.25 mm/s, 0.5 mm/s, 1 mm/s & 2 mm/s (0.01 in/s, 0.02 in/s, 0.04 in/s & 0.08 in/s)	
Minimum data sampling interval in X	0.125 µm (5 µin)	
Straightness accuracy (Pt) <sup>6</sup>	0.15 µm (5.9 µin)	0.18 µm (7.1 µin)
X axis indication accuracy <sup>7</sup>	(1 + 0.02 L) µm	

## Vertical performance

Nominal measuring range (Z) <sup>8</sup>	<b>5 mm Range</b>
Range 1	5 mm (0.20 in)
Range 2	2.5 mm (0.10 in)
Range 3	0.5 mm (0.02 in)
Range 4	0.1 mm (0.004 in)
Resolution (Z) <sup>8</sup>	<b>5 mm Range</b>
Range 1	20 nm (0.79 µin)
Range 2	10 nm (0.39 µin)
Range 3	2 nm (0.079 µin)
Range 4	0.4 nm (0.016 µin)
Range to resolution	262144 : 1
Stylus arm length, tip size, force	120 mm stylus 2 µm radius conisphere diamond, 1mN Force
Z axis non-linearity (Z = gauge displacement)	Resolution + (0.05 Z[mm]) µm (Resolution + (50 Z[inches])µin) after calibration
Repeatability of Z axis indication <sup>9</sup>	Flat surface - 0.10 µm (3.9 µin) <sup>9</sup> Curved surface - 0.10 µm (3.9 µin) <sup>10</sup>

## Electrical (alternating supply, single phase with earth, 3-wire)

Instrument and computer voltage	90V - 230V
Frequency	47 Hz to 63 Hz
Supply voltage transients - width	EN 61000 - 4 - 4
Power consumption	1000 VA

## Air requirements

Air pressure	450 to 1000 kPa (4.5 to 10 bar) (65 to 145psi)
Maximum particle size	5 µm (0.0002")
Moisture content – dew point	+3 °C (37 °F)
Flow rate at operating pressure	150 litres / minute (minimum)
Maximum oil content	25 mg / m <sup>3</sup> (0.01 Grains / ft <sup>3</sup> )
Solid particle content	5 mg / m <sup>3</sup> (0.002 Grains / ft <sup>3</sup> )

## CE conformity

EMC	BS EN 61000-6-1:2001, BS EN 61000-6-4:2001
-----	---

## Motorised Y-Axis column stage

Operation	Software or manual control
Travel	700 mm
Speed	0.25, 0.5, 1.0, 2.0, 5.0, 10.0, 20.0, 50.0, 100.0 mm/s
Tortoise Speed	2.0, 5.0, 10.0, 20.0
Repeatability	5.0 µm

## Motorised rotary and linear stage stack

Rotary stage	CNC 1000	CNC 2000
Travel	360° continuous	
Accuracy	120 arc seconds	
Repeatability	10 arc seconds	
Speed of rotation	1°/s - 180°/s	
Linear stage	CNC 1000	CNC 2000
Travel	300 mm	
Accuracy	± 9.5 µm	
Repeatability	± 1.0µm	
Speed of travel	0.25 mm/s – 100 mm/s	
Stage stack	CNC 1000	CNC 2000
Maximum component weight	75 kg*	150 kg*

## Instrument base and frame (Granite base mounted on a steel frame with pneumatic self-levelling anti-vibration mounts)

Dimensions (mm)	1300 x 1300
Load capability	500 kg Centralised load (Standard Stage stack capacity 75 kg)

## Control cabinet (Contains the PC, electronics and airslide controller)

Dimensions (mm)	555 x 780 x 800 (W x H x D)
Load capability	80 kg

## Measuring station

Motorized tilting of traverse unit	Optional ±9° Tilt from horizontal (Motorised) + Optional 45° Manual
Instrument dimensions	See floor plan
Instrument weight	1200 kg
Motorized vertical column	700 mm (27.6 in), 1000 mm (39.4 in)

## Environment

Operating temperature	18 °C to 22 °C (64 °F to 72 °F)
Storage temperature	5 °C to 40 °C (41 °F to 104 °F)
Operating humidity	45% to 75% relative, non condensing
Storage humidity	10% to 80% relative, non condensing
Maximum RMS floor vibration	3 µm/s (120 µin/s) at < 50 Hz 6 µm/s (200 µin/s) at > 50 Hz

\* Includes weight of fixture.

# Floor plan

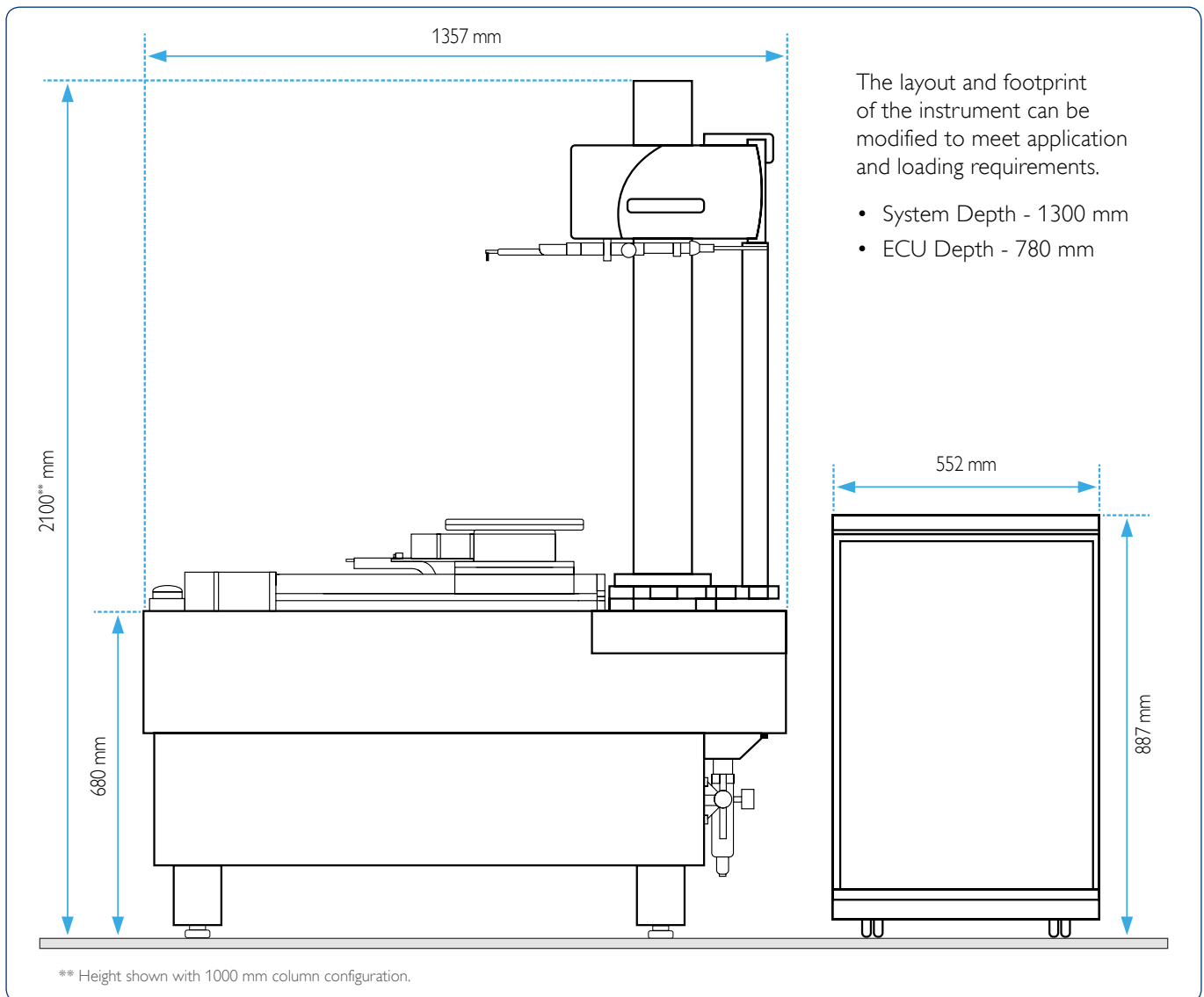

## Safety information

The system is tested to all relevant requirements of:

- BS EN 61010-1, BS EN 349, BS EN 13850, BS EN 983, BS EN 60204 Machinery Directive standards.

The system is designed to be safe when the following conditions apply:

- The system is located indoors in dry conditions.
- Fluctuations in mains supply voltage do not exceed – 10%
- The altitude does not exceed 2000m
- The ambient temperature is between 5° and 40°
- The ambient relative humidity does not exceed 80% for temperatures up to 31°C, decreasing linearly to 50% at 40°C

## Measurement conditions

The quoted technical data is for measurements taken in a metrology laboratory controlled environment: 20°C ±1°C (68°F ± 1.8°F), draft free and isolated from low frequency floor borne vibration.

Uncertainties are at 95% confidence in accordance with recommendation in the ISO guide to the expression of uncertainty in measurement (GUM:1993).

## Notes

1. LS Arc analysis (primary filter  $L_s = 0.25$  mm)
2. Measured over a glass flat nominally parallel to the traverse datum using a 60 mm stylus (i1 & i2), 120 mm stylus (i5) with a diamond stylus (speed = 0.5 mm/s, Gaussian roughness filter, 0.08 mm cut-off, 30:1 bandwidth) in Range 3
3. Assumes a calibration artefact of perfect radius, and use of Gauge Range 1
4. Measurements up and down a  $\pm 35^\circ$  angled slope over 95% of the gauge range using a 60 mm stylus (i1 & i2), 120 mm stylus (i5) with a diamond stylus
5. For surface texture measurements, speeds of 0.5 mm/s (0.02 in/s) and less are recommended.
6. Measured over a glass flat nominally parallel to the traverse datum using a 60mm stylus (i1 & i2), 120 mm stylus (i5) with a diamond stylus (speed = 2 mm/s, LS Line analysis, Cubic Filter 0.8 mm)
7. Where L is in mm
8. Using a 60 mm stylus (i1 & i2), 120 mm stylus (i5) with a diamond stylus
9. Repeated measurements over a glass flat that is nominally parallel to the datum (full traverse length, primary filter  $L_s = 0.8$  mm)
10. Repeated measurements over a 12.5 mm radius standard (i1 & i2), 22.5 mm radius standard (i5) (primary filter  $L_s = 0.25$  mm)

Taylor Hobson pursues a policy of continual improvements due to technical developments. We therefore reserve the right to deviate from catalogue specifications.

### The Metrology Experts

Established in 1886, Taylor Hobson is the world leader in surface and form metrology and developed the first roundness and surface finish measuring instruments.

[www.taylor-hobson.com](http://www.taylor-hobson.com)

### Sales department

Email: [taylor-hobson.sales@ametek.com](mailto:taylor-hobson.sales@ametek.com)

Tel: +44 (0) 116 276 3771

- **Design engineering** – special purpose, dedicated metrology systems for demanding applications.
- **Precision manufacturing** – contract machining services for high precision applications and industries.

### Centre of Excellence department

Email: [taylor-hobson.cofe@ametek.com](mailto:taylor-hobson.cofe@ametek.com)

Tel: +44 (0) 116 276 3779

- **Inspection services** – measurement of your production parts by skilled technicians using industry leading instruments in accord with ISO standards.
- **Metrology training** – practical, hands-on training courses for roundness and surface finish conducted by experienced metrologists.
- **Operator training** – on-site instruction will lead to greater proficiency and higher productivity.
- **UKAS calibration and testing** – certification for artifacts or instruments in our laboratory or at customer's site.

### Service department

Email: [taylor-hobson.service@ametek.com](mailto:taylor-hobson.service@ametek.com)

Tel: +44 (0) 116 246 2900

- **Preventative maintenance** – protect your metrology investment with an AMECare support agreement.



© Taylor Hobson Ltd. 2018



#### Taylor Hobson UK

(Global Headquarters)

PO Box 36, 2 New Star Road  
Leicester, LE4 9JQ, England

Tel: +44 (0)116 276 3771  
[taylor-hobson.sales@ametek.com](mailto:taylor-hobson.sales@ametek.com)



#### Taylor Hobson France

Rond Point de l'Epine Champs  
Batiment D, 78990 Elancourt, France

Tel: +33 130 68 89 30  
[taylor-hobson.france@ametek.com](mailto:taylor-hobson.france@ametek.com)



#### Taylor Hobson Germany

Rudolf-Diesel-Straße 16,  
D-64331 Weiterstadt, Germany

Tel: +49 6150 543 0  
[taylor-hobson.germany@ametek.com](mailto:taylor-hobson.germany@ametek.com)



#### Taylor Hobson Italy

Via De Barzi, 20087 Robecco sul Naviglio,  
Milan, Italy

Tel: +39 02 946 93401  
[taylor-hobson.italy@ametek.com](mailto:taylor-hobson.italy@ametek.com)



#### Taylor Hobson India

Divyasree NR Enclave, 4th Floor, Block A,  
Plot No. 1, EPIP Industrial Area, Whitefield,  
Bengaluru - 560066, India

Tel: +91 80 6782 3346  
[taylor-hobson.india@ametek.com](mailto:taylor-hobson.india@ametek.com)



#### Taylor Hobson China

[taylor-hobson-china.sales@ametek.com](mailto:taylor-hobson-china.sales@ametek.com)

##### Shanghai Office

Part A1, A4, 2nd Floor, Building No. 1, No. 526  
Fute 3rd Road East, Pilot Free Trade Zone,  
Shanghai, 200131, China

Tel: +86 21 5868 5111-110

##### Beijing Office

Western Section, 2nd Floor, Jing Dong Fang  
Building (B10), No. 10, Jiu Xian Qiao Road,  
Chaoyang District, Beijing, 100015, China

Tel: +86 10 8526 2111

##### Chengdu Office

Unit 9-10, 10th Floor 9/F, Hi-tech Incubation  
Park, No.26 West Jinyue Road, Chengdu,  
610041, China

Tel: +86 28 8675 8111

##### Guangzhou Office

Room 810 Dongbao Plaza, No.767 East  
Dongfeng Road, Guangzhou, 510600, China

Tel: +86 20 8363 4768



#### Taylor Hobson Japan

3F Shiba NBF Tower, 1-1-30, Shiba Daimon  
Minato-ku, Tokyo 105-0012, Japan

Tel: +81 34400 2400  
[taylor-hobson.japan@ametek.com](mailto:taylor-hobson.japan@ametek.com)



#### Taylor Hobson Korea

#309, 3rd FL, Gyeonggi R&DB Center, 105,  
Gwanggyo-ro, Yeongtong-gu, Suwon-si,  
Gyeonggi-do, Korea, 16229

Tel: +82 31 888 5255  
[taylor-hobson.korea@ametek.com](mailto:taylor-hobson.korea@ametek.com)



#### Taylor Hobson Singapore

AMETEK singapore, 10 Ang Mo Kio Street 65,  
No. 05-12 Techpoint, Singapore 569059

Tel: +65 6484 2388 Ext 120  
[taylor-hobson.singapore@ametek.com](mailto:taylor-hobson.singapore@ametek.com)



#### Taylor Hobson Thailand

89/45, Moo 15, Enterprise Park, Bangna-Trad  
Road, Tambol Bangkaew, Amphur Bangplee,  
Samutprakarn Province 10540, Thailand

Tel: +66 2 0127500 Ext 505  
[taylor-hobson.thailand@ametek.com](mailto:taylor-hobson.thailand@ametek.com)



#### Taylor Hobson Taiwan

10F-5, No.120, Sec. 2, Gongdao Wu Rd.,  
Hsinchu City 30072, Taiwan

Tel: +886 3 575 0099 Ext 301  
[taylor-hobson.taiwan@ametek.com](mailto:taylor-hobson.taiwan@ametek.com)



#### Taylor Hobson Mexico

Acceso III No. 16 Nave 3 Parque Ind. Benito  
Juarez Queretaro, Qro. Mexico C.P. 76120

Tel: +52 442 426 4480  
[taylor-hobson.mexico@ametek.com](mailto:taylor-hobson.mexico@ametek.com)



#### Taylor Hobson USA

27755 Diehl Road, Suite 300, Warrenville,  
IL 60555, USA

Tel: +1 630 621 3099  
[taylor-hobson.usa@ametek.com](mailto:taylor-hobson.usa@ametek.com)



1100 Cassatt Road, Berwyn, PA 19312, USA  
Email: [info.corp@ametek.com](mailto:info.corp@ametek.com)  
Web: [www.ametek.com](http://www.ametek.com)