

Multi Function Tribometer

MFT-5000

Tribology and Mechanical Tester with
Integrated 3D Profilometer

Multiple ASTM, DIN, ISO Standards Compliant

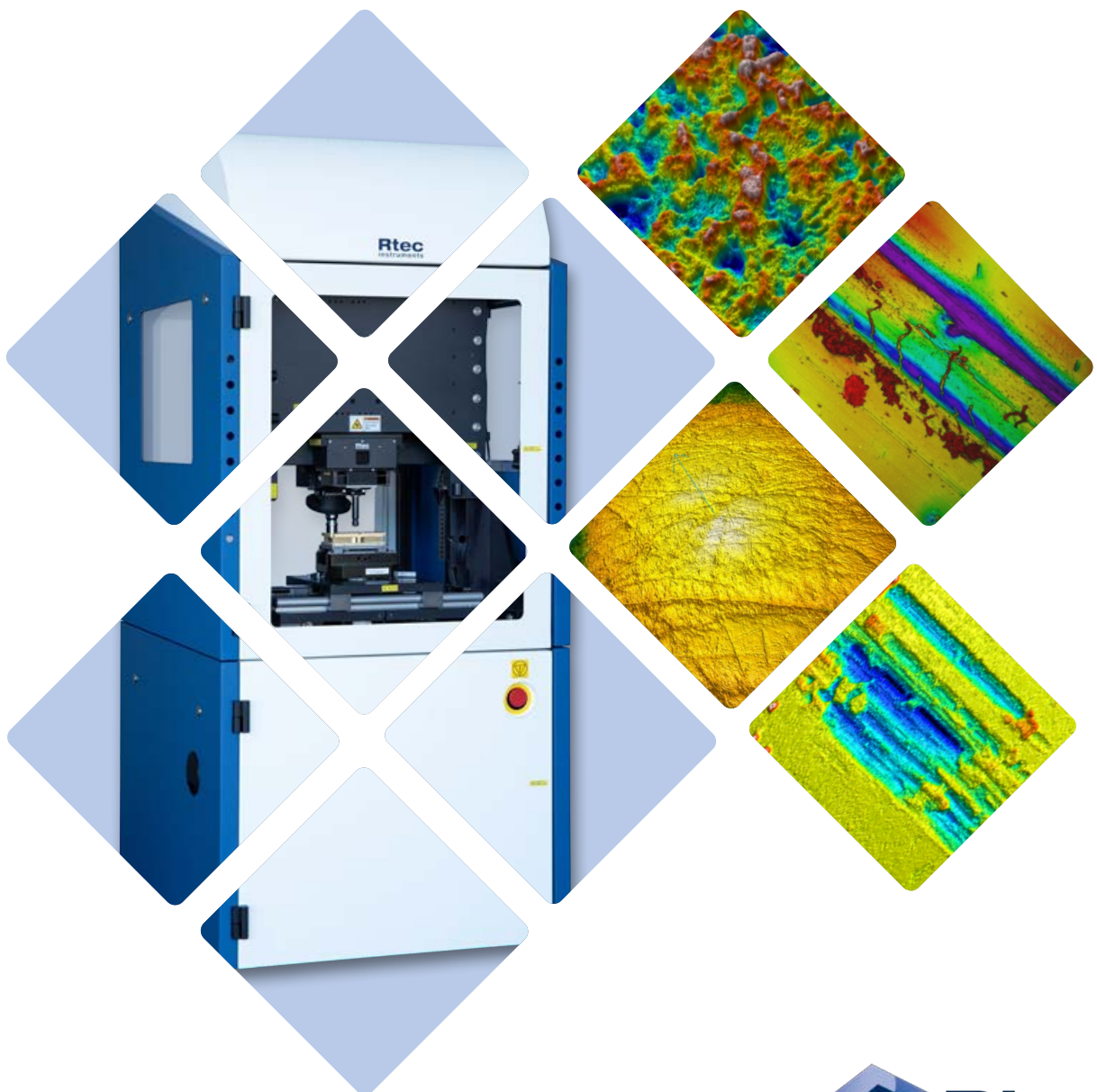

Quality Control

- Wear
- Friction
- Coefficient of Friction
- Adhesion
- Scratch Hardness
- Scratch, Mar Resistance
- Film Thickness
- Step Height
- Hardness
- Modulus
- Fracture Toughness
- nm Resolution 3D Images
- Wear Track, Volume Wear
- Radius of Curvature
- Cracks, Features, Defects
- Chemical Properties
- Fretting
- Tensile, Compression
- High Temperature Hardness

Multi ASTM, DIN, ISO Tests On The Same Platform

Run both standard and non standard tests on coupons or real components

Wide Load Range - Nano, Micro, Macro

Interchangeable load cells to allow a wide range of force ranging from mN to 12,000N

Several Easy To Interchange Test Modules

Test coatings, materials, lubricants across wide test conditions

Integrated In-line 3D Profilometer

Study surface roughness, volume wear, and topography change with test time

Multi Function Or Single Function Configurations

The tester can be configured as a single function test only

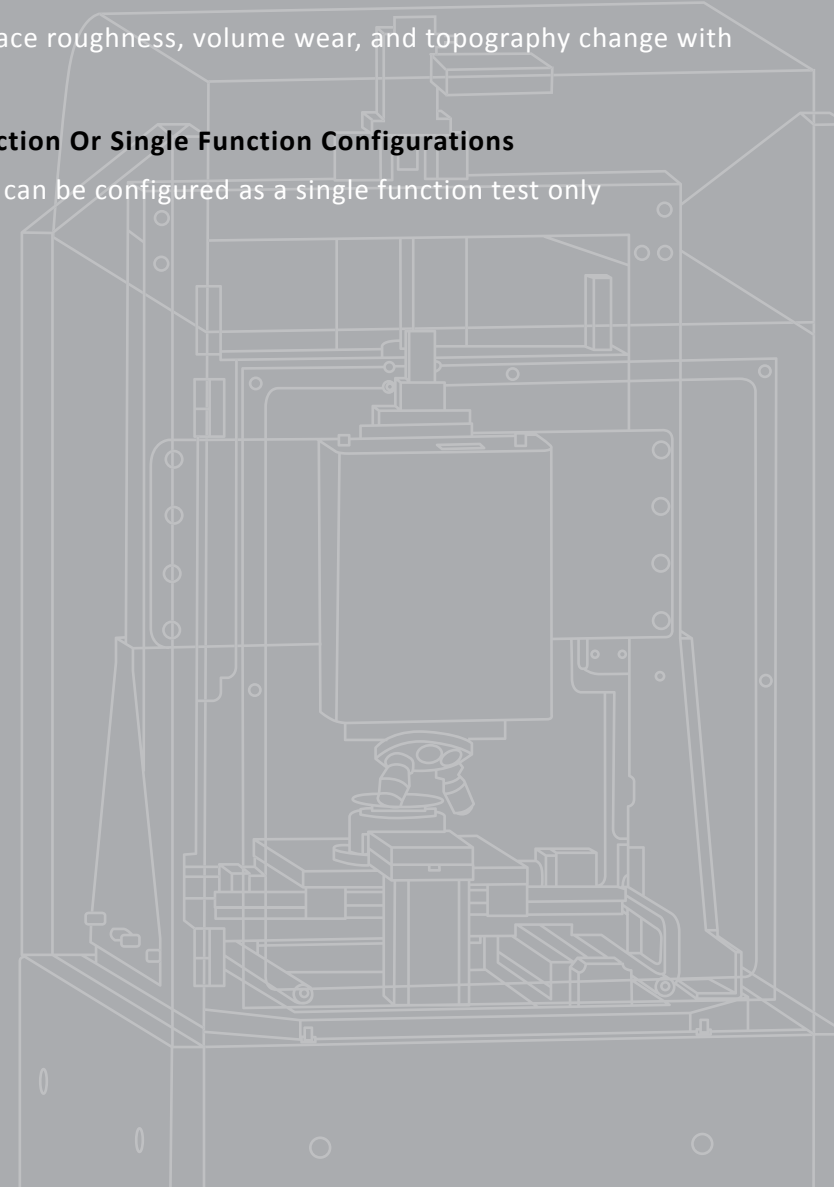

Research & Development

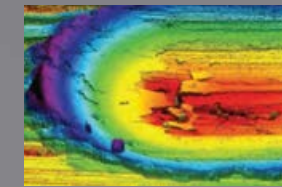

3D Imaging

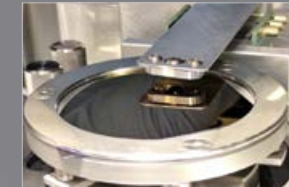

Tribology

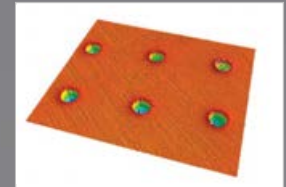

Mechanical Tests

Industry Standard Platform

The patented (US 10132733 B2) state of the art Rtec-Instruments Multi Function Tribometer, the MFT-5000, is globally regarded as the most versatile and technologically advanced tribometer.

The tribometer offers break-through technology in tribology equipment— with ultra low resolution and negligible thermal drift force sensors, highest speeds, widest environmental control range, and ultra accurate stroke control. The patented integrated 3D profilometer analyzes surface change vs time.

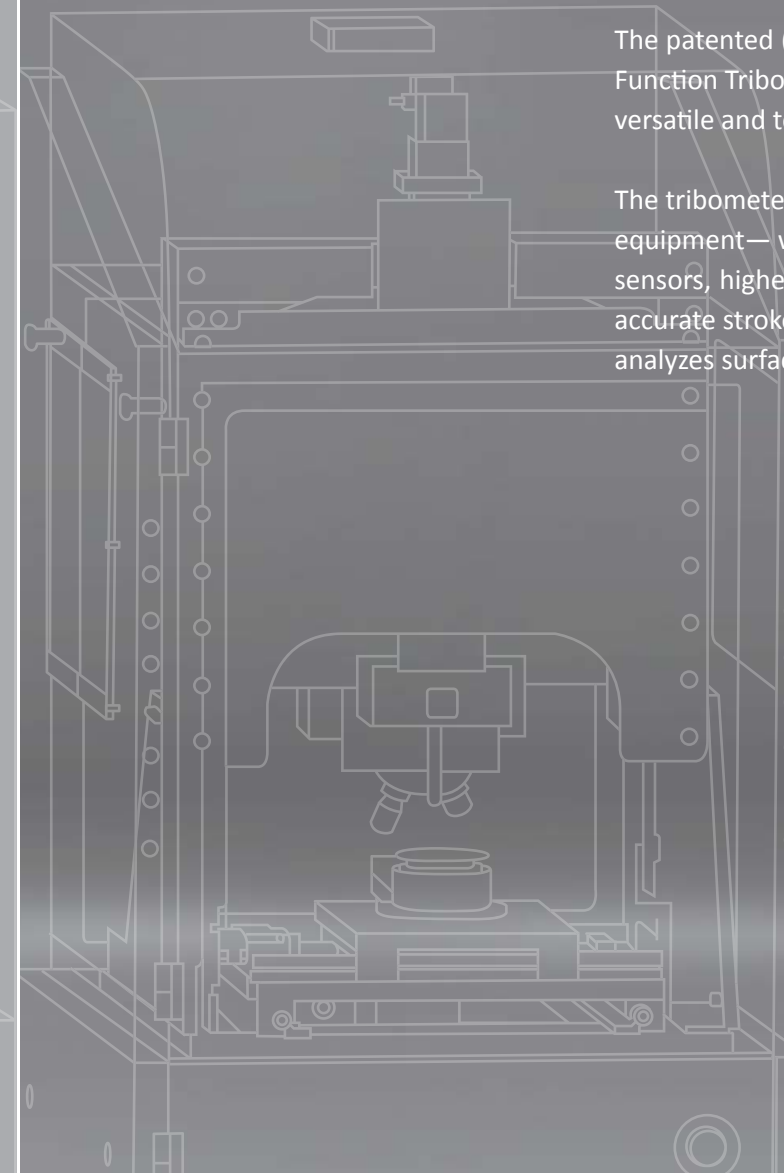

Tribology And Mechanical Tester With Integrated 3D Profilometer



Tribometer Configuration

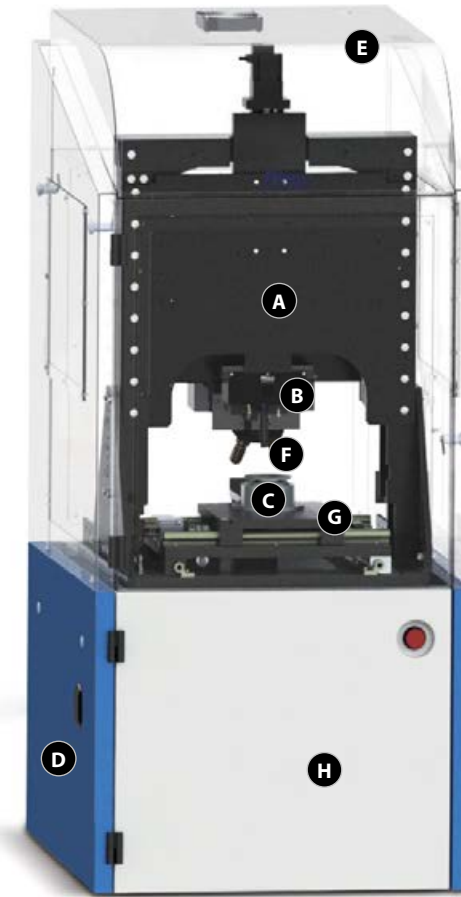

A Upper Z Stage

High precision multiple Z stages to move load cell, profilometer, etc., each independently in Z axis.

B Force Sensor

Interchangeable load cell across a wide range from mN to 12,000N

C Interchangeable Test Modules On top of XY Stage

Interchangeable test modules to perform several tests on the same platform (rotary, reciprocating, block on ring, fretting, scratch, etc.). The modules are mounted using fast-exchange with automatic recognition on top of the xy stage.

D Temperature, Humidity Controller

Closed-loop multi-channel temperature and humidity controller. For -120 to 1200°C temperature control.

E Environmental Isolation

Enclosure to reduce acoustic interference and fumes. Acts as an additional safety guard during test.

F In-line Profilometer

In-line universal 3D Profilometer to image test area automatically with nm resolution. The Lambda profilometer has four imaging modes on same head (confocal + interferometer + dark field + bright field).

G XY Stage

The 130 x 270mm high precision XY stage moves test modules between test and image positions. The stage can also be used for slow speed reciprocating tests, scratch test, custom motion test, etc.

H Data Acquisition, Motion Controller

Advanced high speed, low noise, fast feedback, high data acquisition rate controllers up to 200 kHz, and up to 64 channel expandable capabilities.

Open Platform

U channel design, high Z access provides large working area.

A Tribometer That Comprehensively Characterizes Surface Change vs Time



Tribology Mode

Several Modules Available for Tests

Nano Load

Micro Load

Macro Load

- Rotary Motion
- Linear Motion
- Horizontal Rotation Motion
- Upper Rotation
- Fretting

Imaging Mode

Sub nm automated 3D Images of Surfaces

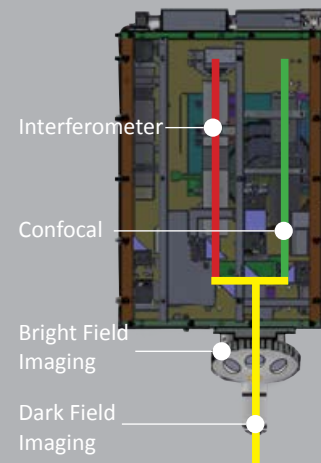

- Surface roughness
- Film thickness
- Wear track
- Volume wear
- Step height
- Add on - Confocal Raman

Patented In-line Profilometer With Automatic Stitching Technology Optimized for Tribology Testing (US 20180024035 A1)

• Steep Slopes

Universal profilometer capable of imaging wear tracks with steep slopes

• Rough, Dark, Smooth Surfaces

The universal profilometer can scan any material (transparent, dark, corroded, flat, curved).

• Auto Stitch Entire Samples

High precision XY stage that allows to scan and stitch entire wear track automatically.

• Image with Liquids

Confocal microscopy can image samples under liquid media.

Sub nm 3D Image of Wear Mark Progression During Test

Test Results

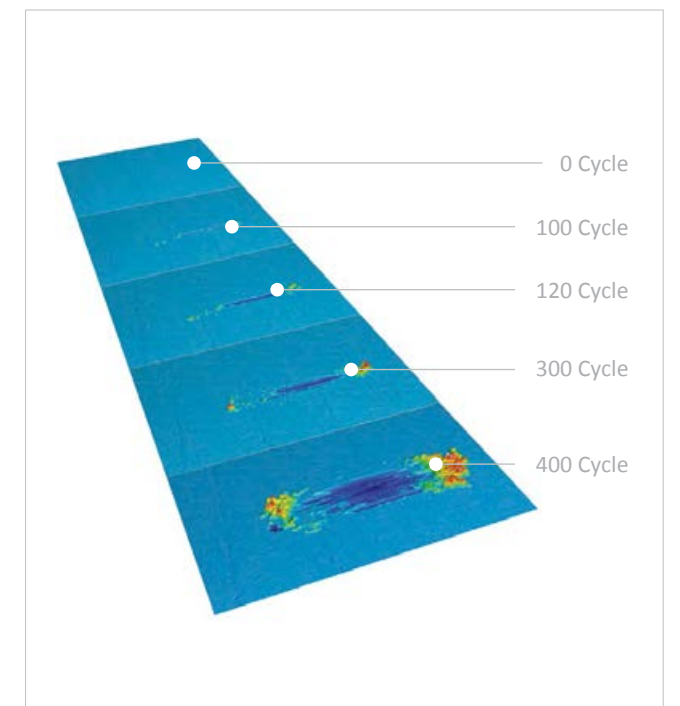
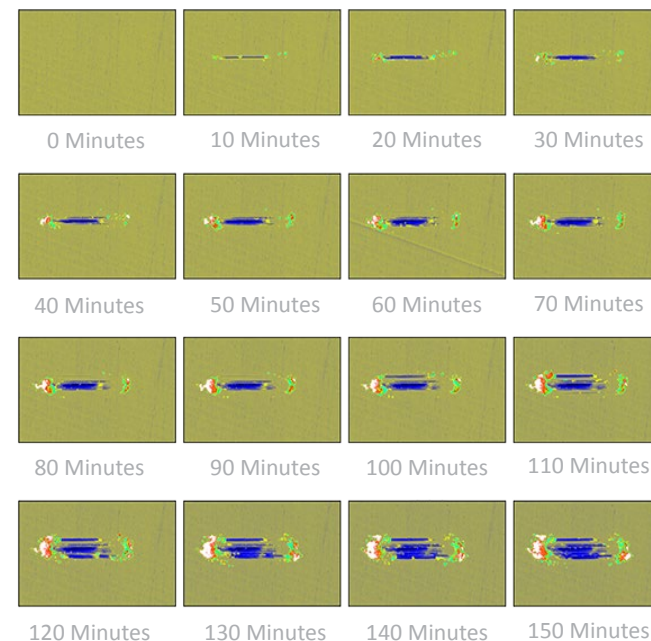

Industry Leading Specification

Technology

- Stroke Control from 5 microns
- High Torque Motors, 50Nm @ 1000 RPM
- High Frequency Capacitive and Piezo Sensors
- In-line Confocal + Interferometer Profilometer
- Widest Environmental Range -120 to 1200°C
- Voice Coil and Flexure Based Actuators

Highest Resolution and Negligible Thermal Drift
Robust Design To Minimise Sensor Damage

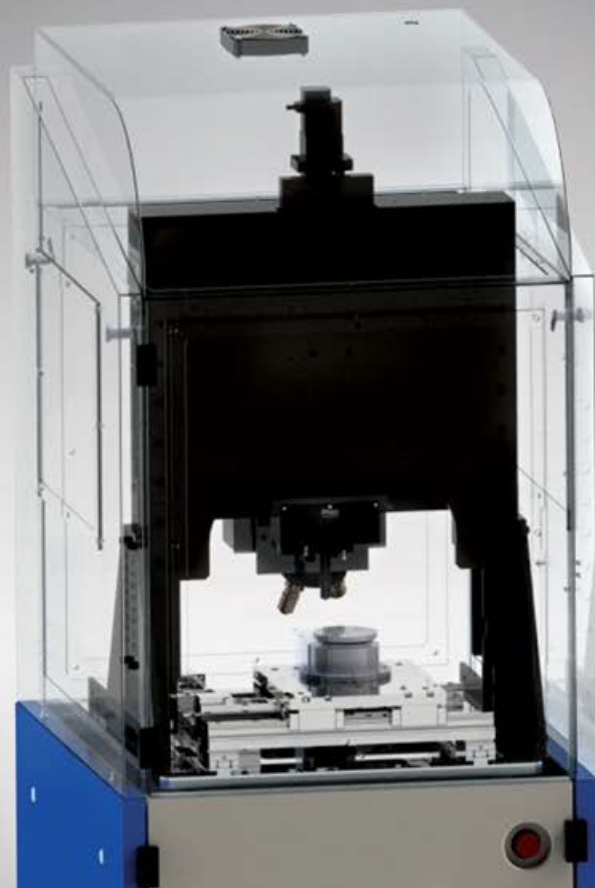

Wide Range Of Sensors With Patented Technology

- **Automatic Recognition**

The tester can mount various interchangeable force sensors easily. Each sensor has an automatic recognition feature, calibration file to maintain optimized performance on testing parameters.

- **Fast Exchange**

- **Highest Resolution**

- **Low Floor Noise**

Based on the application, a sensor from various types of load cells can be selected.

- **Capacitive Load Cells** - Highest resolution load cells with negligible thermal drift.

- **Piezo Load Cells** - Sensors to measure data at highest frequency.

- **Strain Gauge Load Cells** - Sensors with widest load range - mN to 12,000N.

Choice Depends On Application



Capacitive Sensor



Strain Gauge Sensor



Piezo Sensor

Other Types

Torque Sensors / 1D, 2D, 6D Sensors / In-line Dynamic Torque Sensors

Patent # 1017938GB2

Modular Drives With Fast Exchange

Modular Design For Maximum Versatility

MFT-5000 runs tests across a wide range of forces and applications using its modular concept. Various interchangeable modules can be added on the same platform based on the intended application. The modular nature of this tester allows it to test coatings, bulk materials, lubricants, real components, etc.

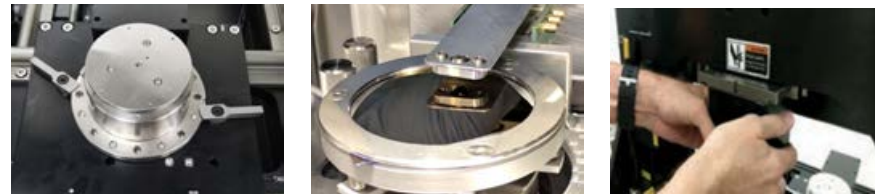

The test modules are quickly swapped. The testing modules, load cells, and lower test drives come with a fast exchange mechanism that allows the user to easily change test configurations.

The software and hardware automatically recognize the test module and runs each test with ease.

| Commonly Used Drives | | |
|---|---|---|
| Rotary Drive | Reciprocating Drive | Block on Ring Drive |
|  |  |  |
| Fretting Drive | Long Stroke High Frequency Drive | Upper Rotary Drive |
|  |  |  |

Environmental Chambers

-120°C to 1200°C
Tribo-Corrosion,
Vacuum,
High Pressure,
and More

The tester comes with several environmental chambers options. The chambers are typically mounted on top of room temperature drives. Using interchangeable chambers, a wide range of -120 to 1200°C, controlled humidity, and vacuum up to 10⁻⁷ torr are achievable. Some setups also allow the MFT-5000 to heat both upper and lower sample separately to simulate real life situations.

The advanced control system allows temperature measurement at multiple points simultaneously. All the chambers are closed-loop controlled, and the requested conditions are controlled using the software automatically. The PID for different ranges of chambers are automatically loaded once an options is mounted.

- Automatic Recognition
- Ease of Use
- Same Software
- Future Field Add-ons
- Cost Effective

| Environmental Chambers | | |
|---|---|---|
| 1000°C | Salt Spray | 500°C |
|  |  |  |
| 1200°C | -50°C | -120°C |
|  |  |  |

Oil, Lubricant Tests, and More

- Multiple ASTM, DIN, ISO
- Stribeck Curves

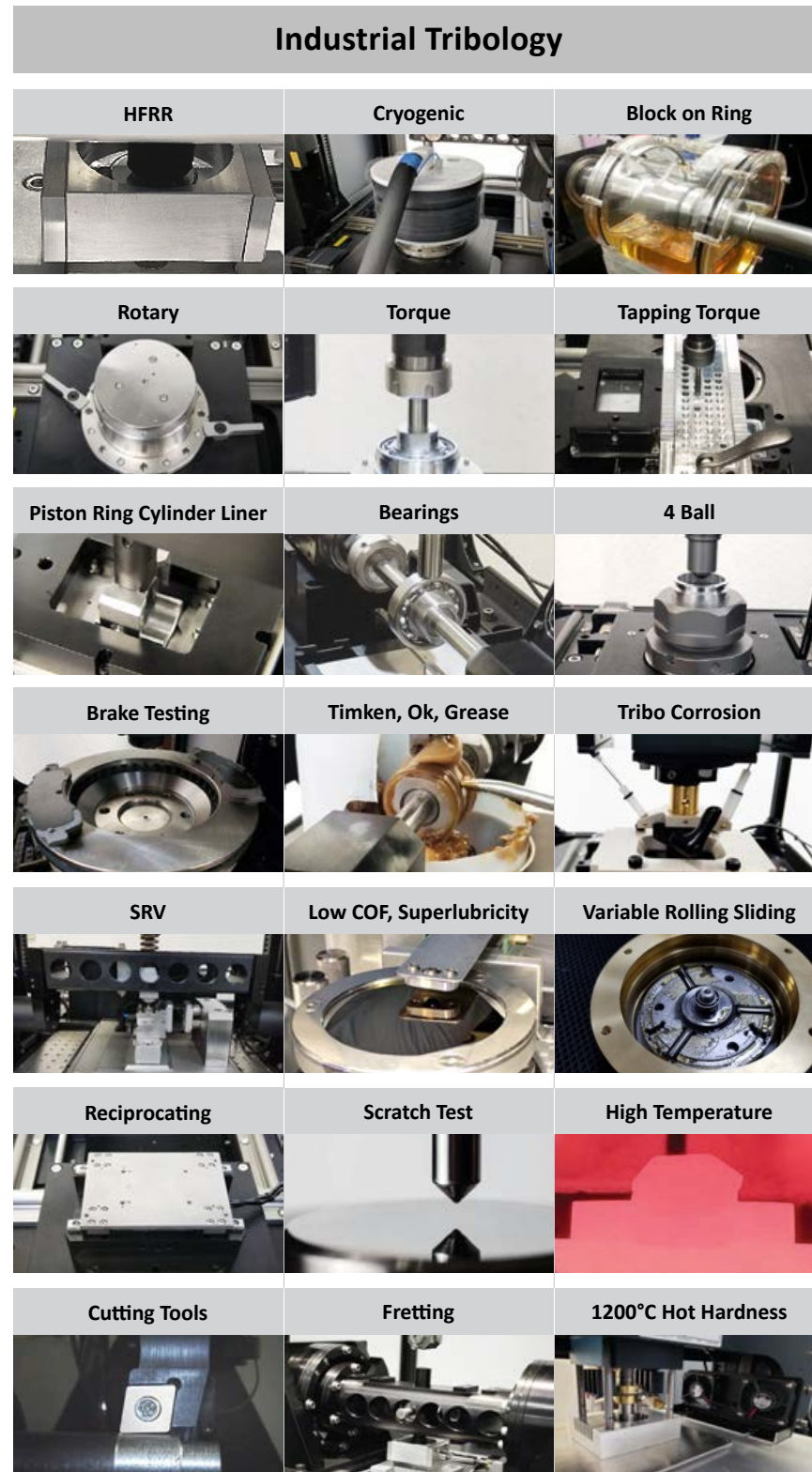

Sturdy Design

The Universal Tribometer is ideally suited for Industrial Tribology involving lubricants, additives, oils, metal working fluids, and many more. The sturdy design includes various lubricant dispensing systems, speeds ranging from 0.001 RPM to 30,000 RPM, and temperature control. This allows the MFT-5000 to precisely develop, characterise, and quality control. Few of the common tribology tests and features are described below.

- Lubricant Recirculation
- High Speed Containers
- Temperature Control
- All Regimes
- Automatic Stribeck
- Up to 12,000 N Force
- Real Components
- Low Friction Measurement at High Loads
- Ultra High Torque Motors
- Certified Reference Calibration Oil, Samples

HFRR

The High Frequency Reciprocating module HFRR is used for evaluating diesel fuel lubricity. The ball slides against a disk with a 1mm stroke at a frequency of 50 Hz. ASTM D6079, D7688, CEC F-06-A-96, ISO 12156-1, IP450, BS-EC590

Linear Oscillating/Fast Reciprocating Test, SRV Test

The standard test determines extreme pressure, friction wear properties of greases, solid bonded films, gear/hydraulic fluids, and lubricant oils. All tests are done in oscillation mode under controlled environmental conditions. ASTM G119, G174, G133, G203, G204, G206, D5706, D5707, D6425, D7217, D7420, D7594, D7421, DIN 51834 and more.

Block on Ring, Timken EP

The block on ring module is typically used to evaluate friction, wear of materials or lubricant/grease where a ring/bearing/shaft is rotated under axial load. ASTM G77, D2509, D2714, D2782, D2981, D3704 and more.

4 Ball Wear, 4 Ball EP, KRL Shear Test

4 ball wear module is used to measure wear-preventing properties of lubricants and greases in sliding and rolling applications; 4 Ball EP is to measure lubricant extreme pressure properties. The test involves rotating one ball on three stationary balls at controlled environmental conditions. ASTM D-2266, D-4172, D-5183D-2596, D-2783 and DIN 51350, IP 239,300.

Tapping Torque, Twist Compression

Tapping torque module characterizes friction, wear, torque, etc., during forming and machining. The test involves tapping/drilling using taps of various standard sizes on materials of choice. Twist compression is designed to measure friction and adhesion in metal forming. Test involves slowly rotating a ring on top of material of choice.

Piston Ring/Cylinder Liner

This test evaluates friction and wear parameters of piston ring and cylinder liner material in presence of engine oils. ASTM G181, G206 etc.

Thrust Washer

This test assess friction and wear parameters of self-lubricated materials in thrust washers, ASTM D3702 etc.

Pin, Ball on Disk

The module measures friction during sliding using pin/ball on disk setup. ASTM G99, G132, DIN 50324 and more.

Stribeck Curve

Stribeck curve displays the evolution of the coefficient of friction as a function of load, velocity and viscosity, users can change the load and velocity to automatically plot Stribeck Curves with ease in all modules

Coatings and Materials

Scratch nm to mm
Thick Coatings
High Temperature

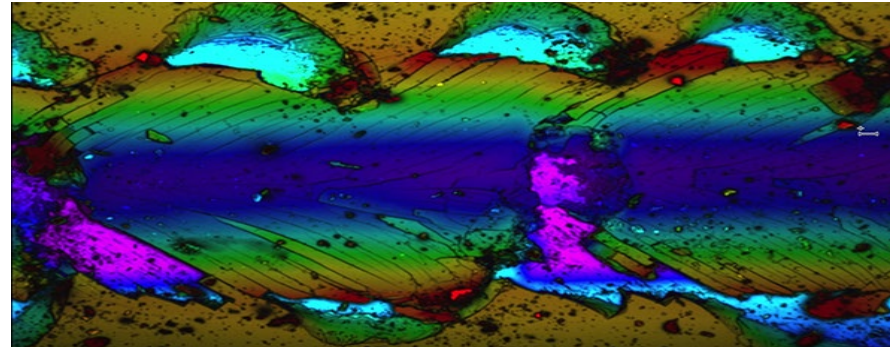

- Hard Coatings
- Polymer Coatings
- Paints
- Soft Coatings
- Optical Lenses
- Decorative Coatings
- Real Components
- 2D Materials
- Thermal Spray Coatings



Scratch, Hot Hardness, Adhesion



Coatings Adhesion, Scratch, and Mar Resistance

The scratch test quantifies adhesion and scratch hardness of coatings. With the advent of new deposition methods and technologies, thinner coatings are finding their way in every aspect of our life. Coatings are present on LCD displays, phones, cutting tools, gems, glass, automobiles, medical devices, etc. The quantitative coating adhesion scratch test is a simple practical test that has been around for a long time. But reliable, reproducible, and comprehensive tests require precise control of the test system configuration and its testing parameters.

The scratch test requires applying a load on the sample that needs to be tested with a spherical or custom tip. During the process of applying the load the sample is moved at a constant velocity and several parameters such as Friction (Fx), Down force (Fz), Coefficient of friction (COF), displacement (Z), acoustic emission (AE), temperature, etc., are measured in-situ.

Mechanical Tests - Hot Hardness, 3-4 Point Bending

The tribometer measures and monitors forces and displacement in all axis. The multi-axis force measurement allows it to run several standard mechanical tests such as hardness, 3-4 point bending, tensile, compression, fatigue, torsion, fretting, etc., tests with ease. All these tests can be done using any of the environmental chambers.

- ASTM
- ISO
- DIN Compliant



Scratch Module

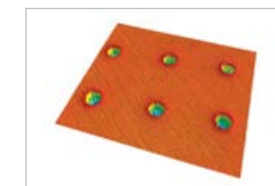

Spherical Indents

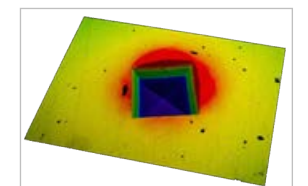

Vicker's Indent

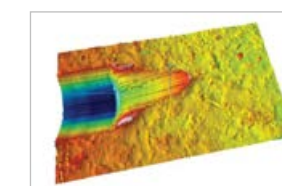

Wear Mark



Hydrogels - Contact Area Change vs Force

Fretting

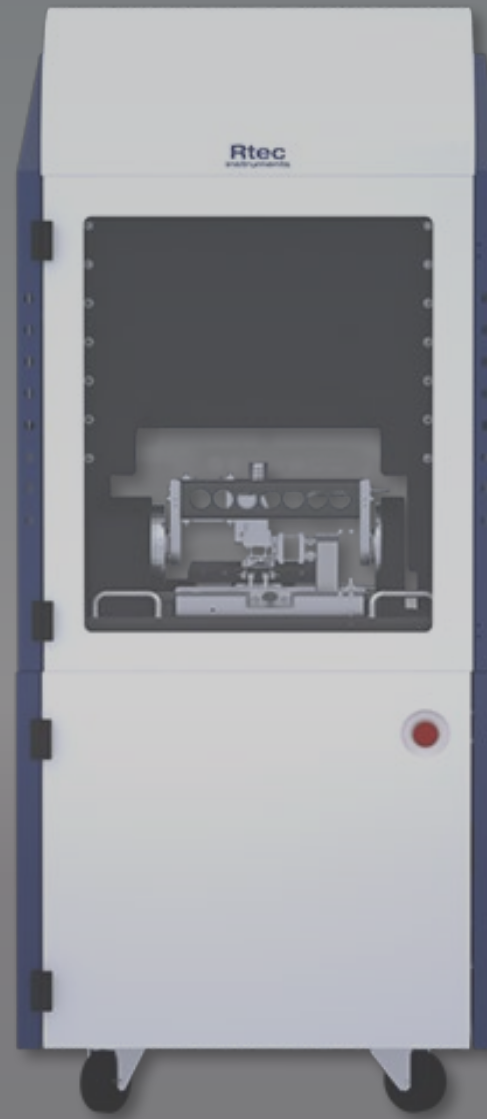

Voice Coil

Fretting test modules cover a wide test load range. Technology break through in voice coil control, high frequency signal processing algorithms are capable of running fretting wear tests with less than 5 micron stroke.

The test module comprehensively characterizes fretting wear from micron to macro scale. Ultra sensitive piezo based load cells, combined with a robust design, high stiffness holders, and low floor noise provides quantitative fretting wear characterization of materials, interfaces, thin films, components, etc.

To simulate real life scenarios, the tests can be done in controlled environmental conditions. Easy to use and intuitive data interpretation makes this tester an ideal tool in hands of researchers or quality control engineers.

Real Time Stroke Control

The Smallest Controllable Stroke - less than 5um to 4mm, up to 500Hz

Real time stroke, frequency monitoring, and correction using LVDT.

Environmental Control, Surface Electrical Measurement

Humidity, temperature, inert gas, and electrical measurements for real life simulation.

High Reliability - Flexure Design

The flexural suspension guides the magnet assembly without bearings.

High Frequency Response Force Sensors

Piezo based sensors that can measure friction force with ultra high accuracy at high frequency reciprocating test.

Unmatched Performance

High Speed Controllers

Fretting

Fretting wear is a test where surface damage occurs between two contacting surfaces experiencing oscillatory displacement of a small amplitude.

Debris

- Debris formation from asperity contacts
- Oxidation at contacting surface due to humidity, temperature, or chemical composition change
- Oil, lubrication starvation regimes causing wear
- Wear due to electric discharge
- Repetitive collision between surfaces
- Fatigue related cracks - onset of debris
- Polymerization of organic materials at surface
- Fine powdered debris - highly oxidized
- Residual steady stage flow of debris
- Diffusive wear
- Melting wear

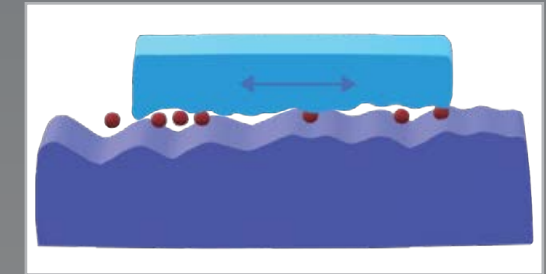

Sample under fretting motion

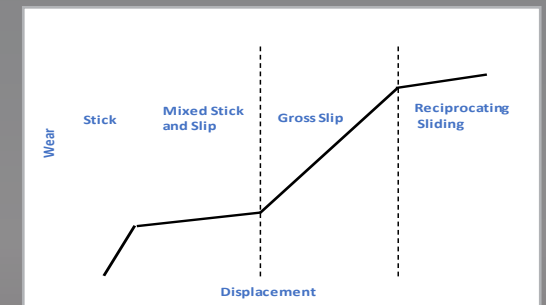

Regime Schematics

Specification Summary

FFT-M2 1000N Down Force
FFT-M1 300N Down Force

- Actuators**
- Displacement 5um-4mm
 - Resolution: 0.1um
 - Oscillation frequency: Up to 500Hz

- Environment**
- Up to -40°C, 180°C, 500°C, 1000°C
 - Humidity controlled chamber

- Sensors**
- Potentiostat
 - Acoustic Emission
 - Electrical Contact Resistance

- Common standards**
- ASTM E2789
 - ISO 19291
 - ASTM D6425
 - ASTM D7421
 - ASTM D5707
 - ASTM D5706
 - ASTM D7594
 - DIN 51834-2
 - DIN 51834-3
 - DIN 51834-4

Nano Tribology

- 2D Materials
- Polymers
- Soft Coatings
- Paints
- Lens
- Optical Coatings
- Displays

Superlubricity, 2D Materials, DLC etc.
Low Friction Force Measurements

• Negligible Thermal Drift Force Sensors

• Capacitive Load Sensors With High Resolution

• COF Measurement < 0.002

The nano tribometer modules allows for a comprehensive friction, wear, adhesion, etc. characterization over nano to micro scale. Ultra sensitive capacitive load cells, combined with low floor noise, and a robust design provide quantitative tribology characterization of interfaces, thin films, 2D materials, superlubricity, and much more. The tests can be done in air, vacuum chamber, or in a controlled inert gas atmosphere. The wear mark can be easily imaged using in-line profilometer and Raman spectrometer to characterise roughness, wear and chemical property across the track automatically.

Ultra Low Friction,
nm to Micron Films, Coatings



Precision At Best

Superlubricity

The tribometer uses decoupled capacitive load cells to measure friction at a COF 0.001 level even at high down forces (1N, 10N etc.). The unique design, controlled environmental condition, and high resolution sensors measure friction for 2D materials, and superlubricity with ease.

In-situ Confocal Raman Spectroscopy

In-line confocal Raman spectroscopy can be added to the tribometer. The confocal mode allows to image the chemical property of locations within the wear mark with high resolutions. The XY stage allows stitching of the Raman maps across the entire wear track. The test can be performed in air, inert gas, or in a vacuum chamber.

Touch Screen, Display, and Glass

The tribometer uses a 6D sensor and closed-loop XY stage to create customized motions, such as butterfly, circular, and zig-zag that simulate any kind of profile. The test is used to simulate finger motion on touch screens accurately to quantify perception.

Contact Area vs Force

The surface adhesion module can be added to the tribometer to analyze real time contact area vs force using an imaging system that is placed under the sample. This calculates surface adhesion and also observes the interface in real time.

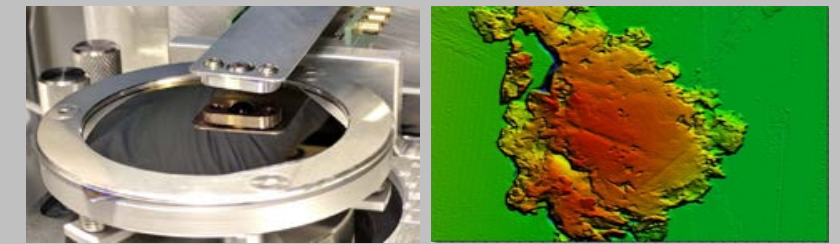

Ball on disk setup for nano tribology agglomerated particles on a coating.

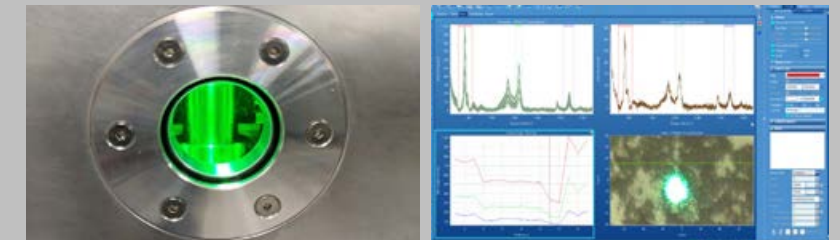

Vacuum chamber with in-line Raman and profiler Raman spectrometer data on a wear mark.

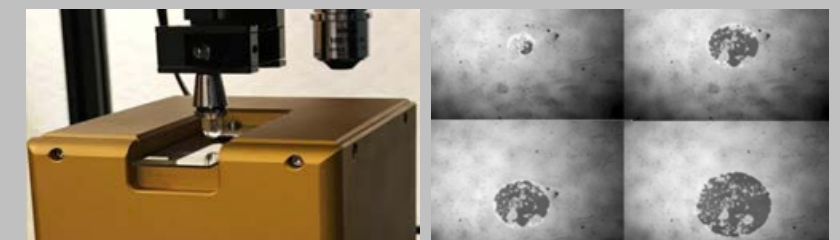

A test showing hydrogel against a coated glass slide. Real time contact area analysis vs force.

Software

The tester comes with a powerful operation, statistical and image analysis software. All software is Windows based and is very easy to learn and operate. The software runs the tool in advanced mode for experienced users, or simple mode for new users or operators. The data can be saved in proprietary format or in ASCII format.

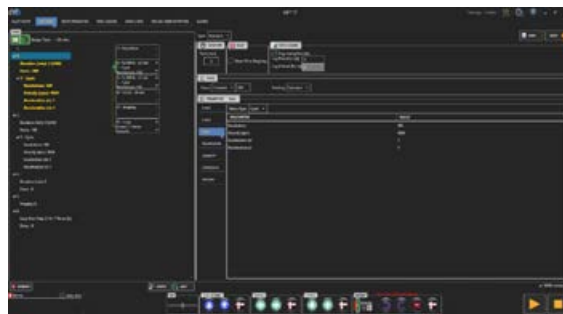

Abort Criteria

Each test step can be stopped by user's defined logical criteria.

Automatic Recognition

The testing system recognizes load cells and drives automatically and the associated calibrations files.

Recipe Driven

Each test can be controlled by a series of command blocks forming a protocol or "recipe." The recipes are saved and easily drive the instrument.

Easy to learn

The software is intuitive and easy to learn.

Test Library

The instrument comes with a series of test protocols that match user's applications and can easily be modified.

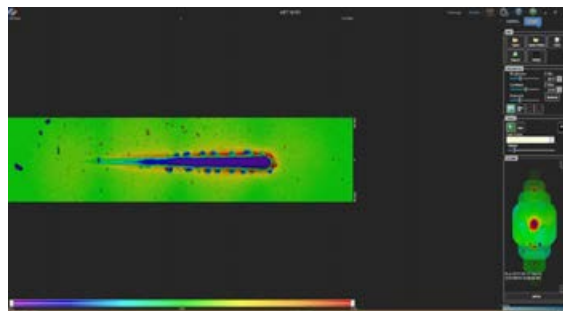
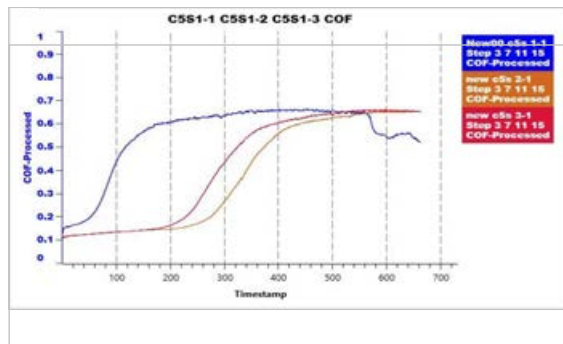

Automatic Image, Tribology Data Correlation

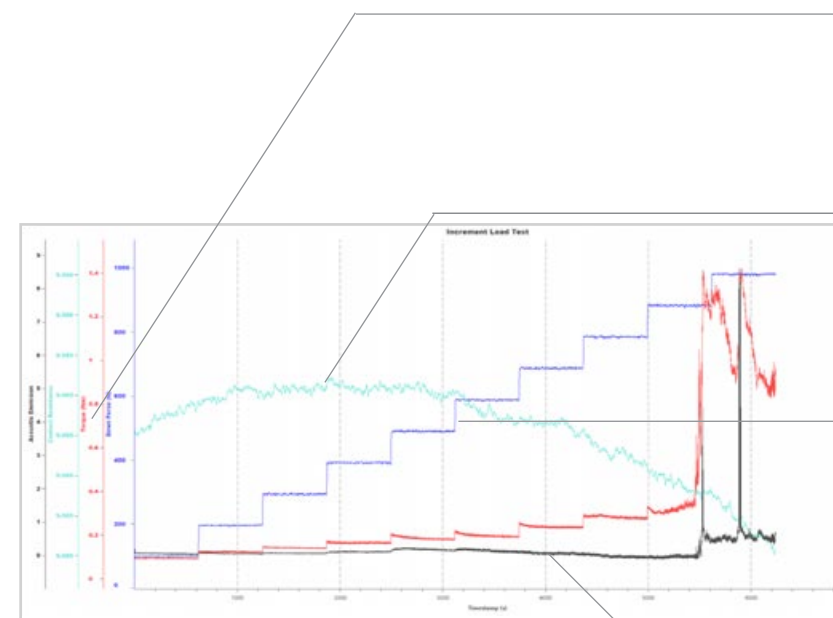

- Torque, friction, acoustic emission, and downforce are recorded and displayed in real time. As the failure starts to happen, the forces jump.
- Electrical contact resistance sensor measures the surface electrical properties. The film quality in real time can be quantified using the sensor.
- Down force is recorded and displayed in real time. This test shows step increase in down force. The force can be controlled in constant, linear or user defined modes.
- The acoustic emission signal indicates initiation of failure at the test interface. The sensor uniquely filters out the motor and ambient noise and shows the interfacial acoustic signal.

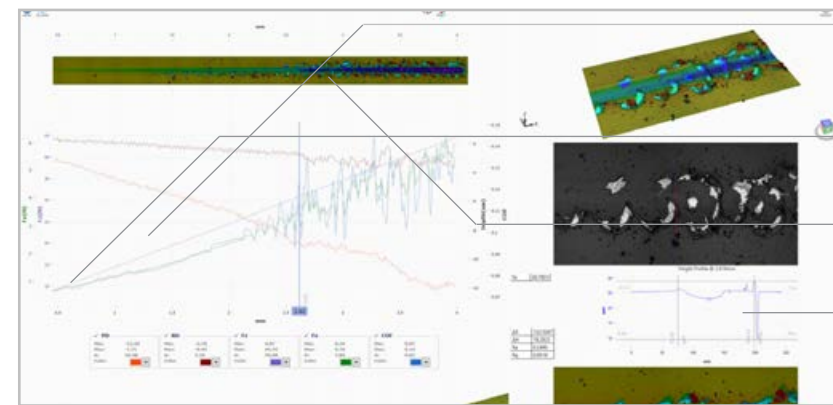

- Synchronized 3D, 2D, Image and data zoom
- Friction, Wear, and Depth Data
- Image associated with the wear mark.
- Roughness, Wear volume associated with the track

Wide Applications

The versatility of tester allows the tribometer to play an important role for several applications. It can be used for thin or thick films, lubricants, materials, soft materials, hydrogels, bio materials, smooth or rough surfaces, flat or rough surfaces, transparent or opaque surfaces, nano or macro scale, coating or bulk materials, and more.

High Temperature

- Hot hardness Tester (up to 1200°C)
- High Temperature Tribology (up to 1200°C)

Lubricants, Grease

- Block on Ring, Timken OK
- 4-Ball EP and Wear
- HFRR
- Twist Compression
- SRV
- Tapping Torque, Cutting, Drilling
- Piston Ring Cylinder Liner

Mechanical

- Hot Hardness
- 3, 4 Point Bending
- Adhesion

Cryogenic

- Low temperature Tribology (from -120°C)

Corrosion Testing

- Tribo Corrosion
- Salt Spray

High Pressure

- Compressor

Friction Wear

- Rotary Pin on Disk Tribometer, Ball on Disk
- Reciprocating
- Brake Materials Tribology
- Fretting
- Low Friction, Nano Tribology
- Bio Tribology

Coatings

- Scratch Test, Adhesion, Hardness
- 2D Materials, Low Friction Coatings
- Fretting
- Pin on Disk, Ball on Disk
- Reciprocating
- Fracture Toughness
- High Temperature Tribology up to 1200°C
- Scratch and Mar Resistance

Industrial

- Brake Materials Screening
- Optical lens
- Cutting Tools, Hard Coatings
- Piston Ring Cylinder Liner
- High Pressure Chamber
- Aerospace Tribology
- Textile
- Bearings
- Additive Manufacturing

Platform Specification

- Floor standing- Micro, Macro
- Bench top- Nano, Micro
- Data Acquisition 200 kHz

XY Stage

- Range: 130x270mm
- Motion resolution: 0.1µm
- Maximum speed: 50mm/s

Multiple Z Stages

- Max speed: 10mm/s, 500µm/s
- Motion resolution: 0.25µm, 10nm

Computer Console

- Latest Windows OS
- LCD monitor

Facilities Requirement

- Power Requirements: 110 VAC/ 240 VAC /480VAC

Environmental Chambers (Optional)

- -120°C up to 1200°C
- 5 to 90% RH
- Vacuum
- Liquid
- Inert gas
- Corrosion
- Salt Spray
- High Pressure

Surface Inspection

Various Imaging Modules

- White light interferometer
- 3D Confocal microscope
- Variable Focus
- Raman spectrometer
- High mag. microscope
- Atomic force microscope

Additional Sensors

- Potentiostats
- Acoustic emission
- Electrical resistance
- pH probes

Test Modules

Various Mechanical Heads

- Tribometer
- Indentation
- Scratch
- Mechanical

Lower Drives

All drives are in addition to drives mentioned in platform specification

Rotary Drive

- Range 360°
- Max speed up to 30000 RPM
- Min speed 0.001 RPM (low speed drive)

Fast Reciprocating Drive

- Speed up to 80Hz
- Stroke 0.1mm to 30mm

Long Stroke Fast Reciprocating

- Speed 35Hz
- Stroke 40mm at 40Hz

Fretting Drive

- Speed up to 500Hz
- Stroke 5 µm to 4mm

Block On Ring Drive

- Range 360°
- Speed up to 7000 RPM

About us

Rtec-Instruments develops and manufactures advanced imaging and surface mechanical property measurement solutions for research and industrial applications. Based in Silicon Valley, we are the leading provider of testing instrumentation such as tribometer, optical profilometer, 3D scratch tester and micro/nano hardness tester.

We share a philosophy that embraces collaboration and partnership with customers, leaders in academia and industry, to ensure that our products answer real needs with innovative solutions.



Rtec Instruments, US
1810 Oakland Road, Ste B
San Jose, CA, 95131, USA
Phone: +1 408 708 9226

Rtec Instruments, SA
Rue Galilée 6,
1400 Yverdon-les-Bains, Switzerland
Phone: +41 24 552 0260

Rtec Instruments, CN
Room 1002-2, Building 1, #69 Olympic St
Jianye District, Nanjing, China, 210019
Phone: +86 25 83210072,+86 18013892749